

# Rider's Manual

## US Models



**K75**

**K75S**

**K75RT**

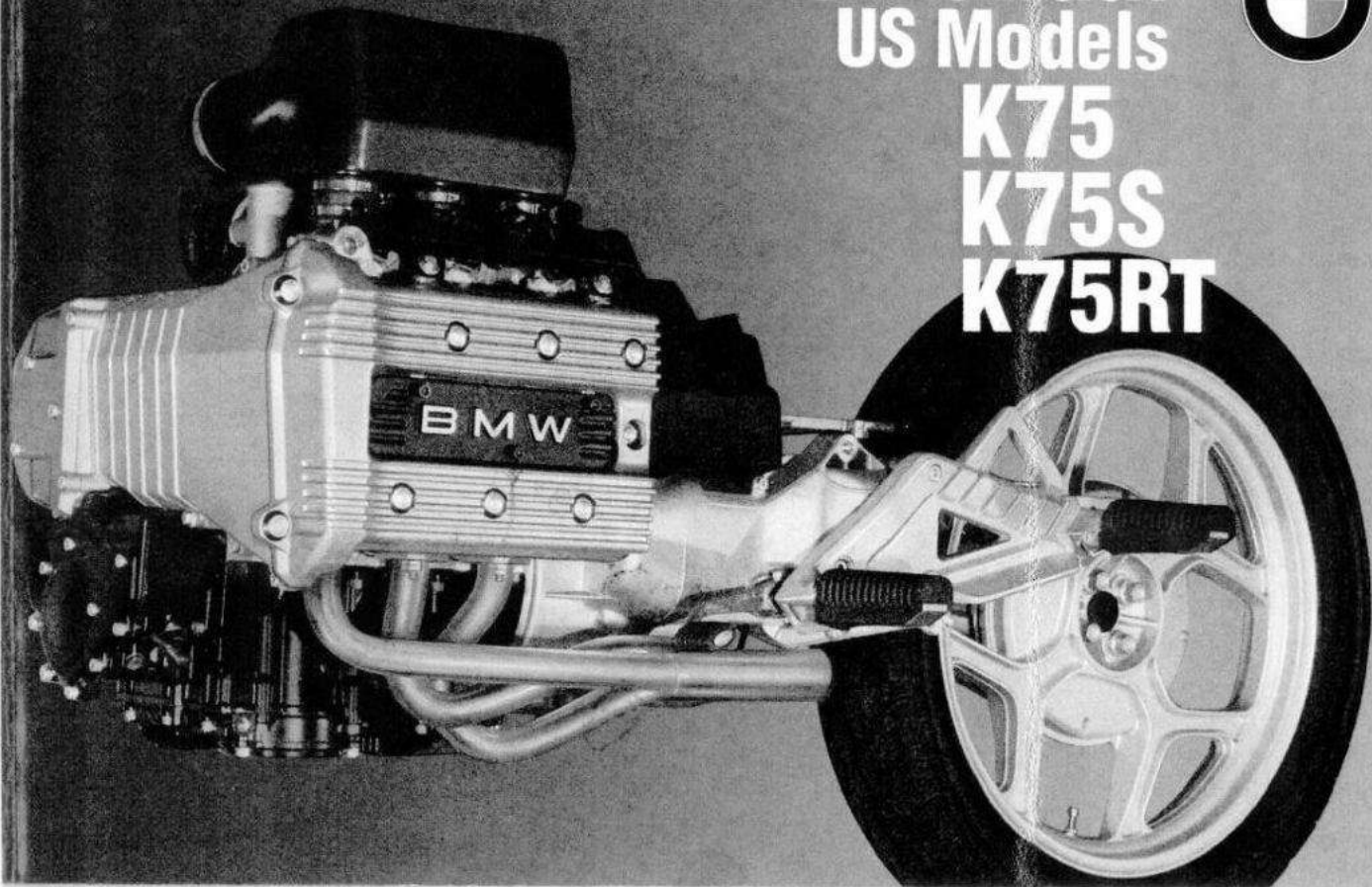

## **Reporting Safety Defects!**

If you believe your vehicle has a defect which could cause a crash or could cause injury or death, you should immediately inform the National Highway Traffic Safety Administration (NHTSA) in addition to notifying BMW of North America, Inc., P.O. Box 1227, Westwood, New Jersey 07675-1227, Telephone (201) 307-4000.

If NHTSA receives similar complaints, it may open an investigation, and if it finds that a safety defect exists in a group of vehicles, it may order a recall and remedy campaign. However, NHTSA cannot become involved in individual problems between you, your dealer, or BMW of North America, Inc.

To contact NHTSA, you may either call the Auto Safety Hotline toll-free at 1-800-424-9393 (or 366-0123 in Washington, DC area) or write to: NHTSA, US Department of Transportation, Washington, DC 20590. You can also obtain other information about motor vehicle safety from the Hotline.

# **Rider's Manual**

## **US Models**

**K 75**

**K 75 S**

**K 75 RT**



**BMW AG Motorcycle Division**

## Important Notice

Your BMW motorcycle conforms to all applicable U.S. Federal Motor Vehicle Safety Standards and U.S. Environmental Protection Agency Regulations effective on the date of manufacture.

**This motorcycle has been designed for use in a prudent and reasonable manner by a qualified operator. It is intended for on-road use as a vehicle only.** Operation in forest, bush or grass covered areas may be illegal. Obey local laws and regulations.

Whether you are a novice or an experienced rider, **become familiar with this Rider's Manual before you ride the motorcycle.**

Pay special attention to passages which are preceded by the following expressions:

- |                |  |
|----------------|--|
| <b>Warning</b> | – marks the possibility of <b>danger</b> for the operator or another person, unless instructions are followed. |
| <b>Caution</b> | – marks the possibility of <b>damage</b> to the motorcycle or parts thereof, unless instructions are followed. |
| <b>Note</b>    | – marks recommendations which are useful or vital for proper <b>use or maintenance</b> of your motorcycle.     |

It is recommended that maintenance be performed by an authorized BMW dealer using Original BMW parts.

**Maintenance, replacement or repair of the emission control devices or systems may be performed, at your expense, by any motorcycle repair establishment or individual using any motorcycle part which is certified under those regulations without voiding the warranty.**

**In the interests of continuing technical development, we reserve the right to modify designs, equipment and accessories.**

Dimensions, weights and performance data are listed at generally accepted tolerances. Errors and omissions excepted.

Please note that any discrepancies between your motorcycle and the details given in this book may be due to the equipment specification offered on a particular model or the version offered in another country. No claims based on data statements, descriptions or illustrations from this book will be entertained.

Errors and omissions excepted.

© 1995 BMW AG Motorcycle Division

Not to be reproduced wholly or in part without the written permission of

BMW AG Motorcycle Division

Technical Service Department.

Printed in the Federal Republic of Germany.

**Dear motorcyclist and  
BMW enthusiast,**

We congratulate you on choosing a BMW motorcycle and welcome you to the group of BMW riders.

Safety is a prime consideration in motorcycling. The better acquainted you are with the motorcycle, the more comfortable you will feel in road traffic.

That is why we ask you to please spare a little time to read this Rider's Manual thoroughly before you start serious riding. It contains important information on operating your motorcycle to enable you to fully appreciate your BMW. You will also find helpful information regarding care and maintenance to ensure that your BMW motorcycle is always in proper operating condition to help ensure maximum road safety and retention of its value.

In conclusion, we wish you and those who ride with you many an enjoyable journey.

Yours sincerely,

**BMW AG Motorcycle Division**

## **Please Note: Important Safety Information!**

**For your personal safety, BMW NA of North America, Inc. ("BMW NA") recommends that you use only parts and accessories approved by BMW NA.**

By using Original BMW Parts and Accessories tested and approved by BMW, you can enjoy the assurance of knowing that these products have been certified after appropriate testing as suitable for use on, or in conjunction with, your BMW motorcycle. BMW NA assumes full responsibility for these products when used as directed.

**BMW NA assumes no liability whatsoever for parts and accessories which it has not approved.**

When you use such non-approved products on your BMW motorcycle, you do so at your own risk. BMW NA is unable to determine whether each after-market part and accessory can be used without representing a risk of injury or death to you and/or your passenger.

Original BMW Parts, BMW Accessories and other products approved by BMW NA, together with competent advice on all matters concerning them, can be obtained from any authorized BMW motorcycle dealer.

**Operating instructions**

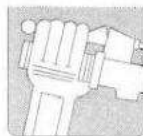

**Safety check**



**Starting – Riding – Parking**



**Care and maintenance**

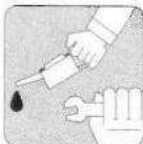

**Specifications**

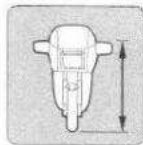

**Alphabetical index**

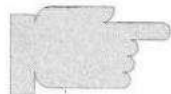

# Operating instructions

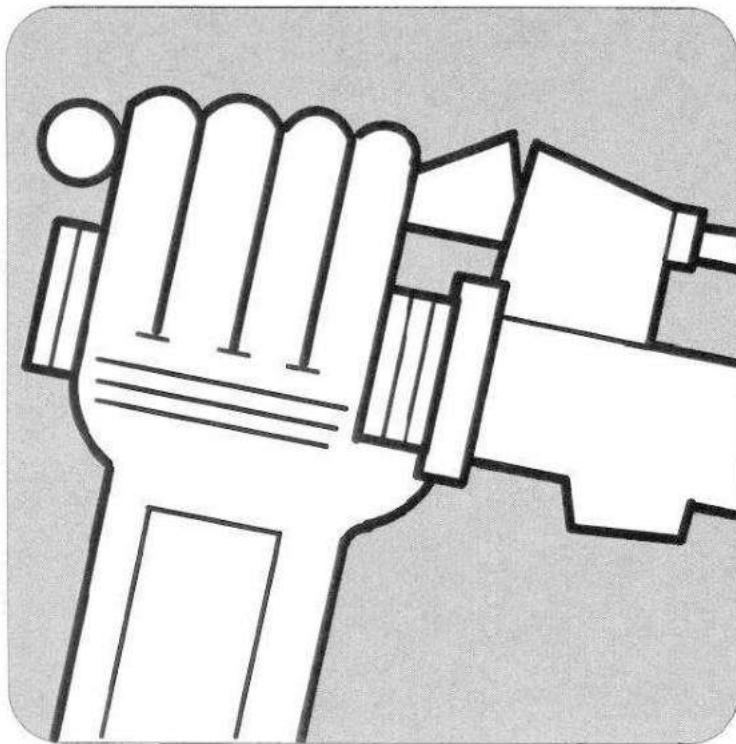

## Where is everything?

- General views of motorcycle (8-11)

## How does it work?

- Ignition and steering lock (12)
- Left instrument unit (13)
- Central instrument unit (13)
- Right instrument unit (13)
- Fuel gauge (14)
- Temperature gauge (14)
- Left handlebar controls (15)
- Right handlebar controls (15)
- Self-cancelling turn-signals (15)
- Hazard warning flashers (16)
- Heated handlebar grips (16)
- Power sockets (17)
- LCD-Digital clock (17)
- Radio (18)
- Adjusting windshield (18)
- Reading lamp (18)
- Storage space (19)
- Releasing dualseat lock (19)
- Anti-lock braking system (ABS) (20-23)

( ) Figures in brackets ⇒ Page on which item is described.



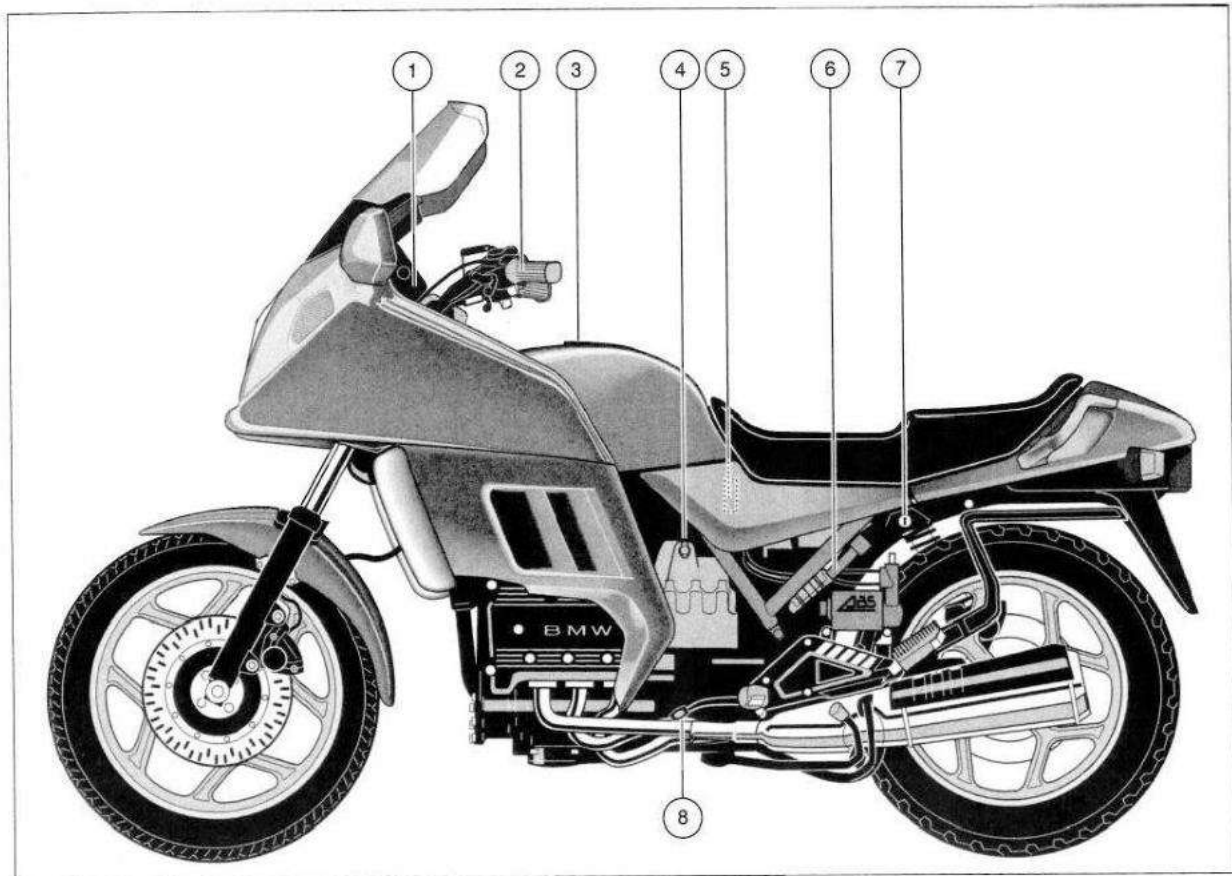

## Where is everything?

- 1 Instrument cluster (13)
- 2 Left handlebar controls (15)
- 3 Fuel tank filler cap (28)
- 4 Socket (17)
- 5 Fuse box (59)
- 6 Lifting handle (44)
- 7 Dualseat lock, helmet holder (19)
- 8 Gear pedal (43)

( ) Figures in brackets ⇒ Page on which item is described

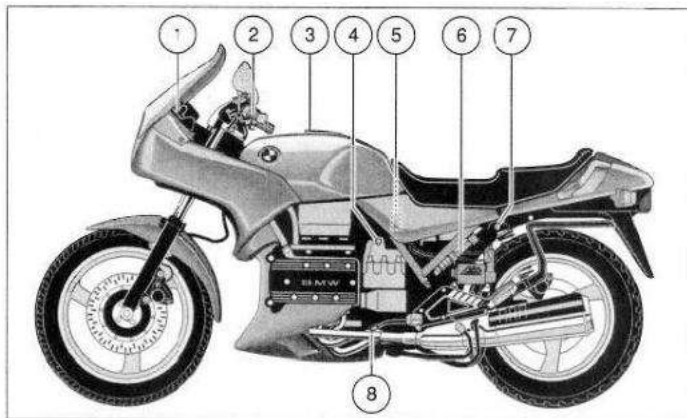
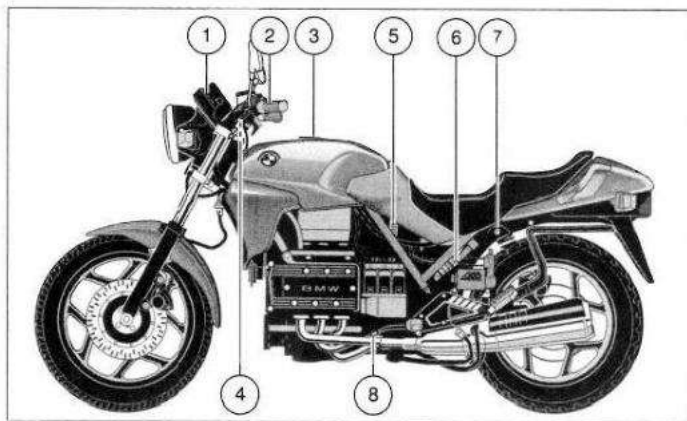

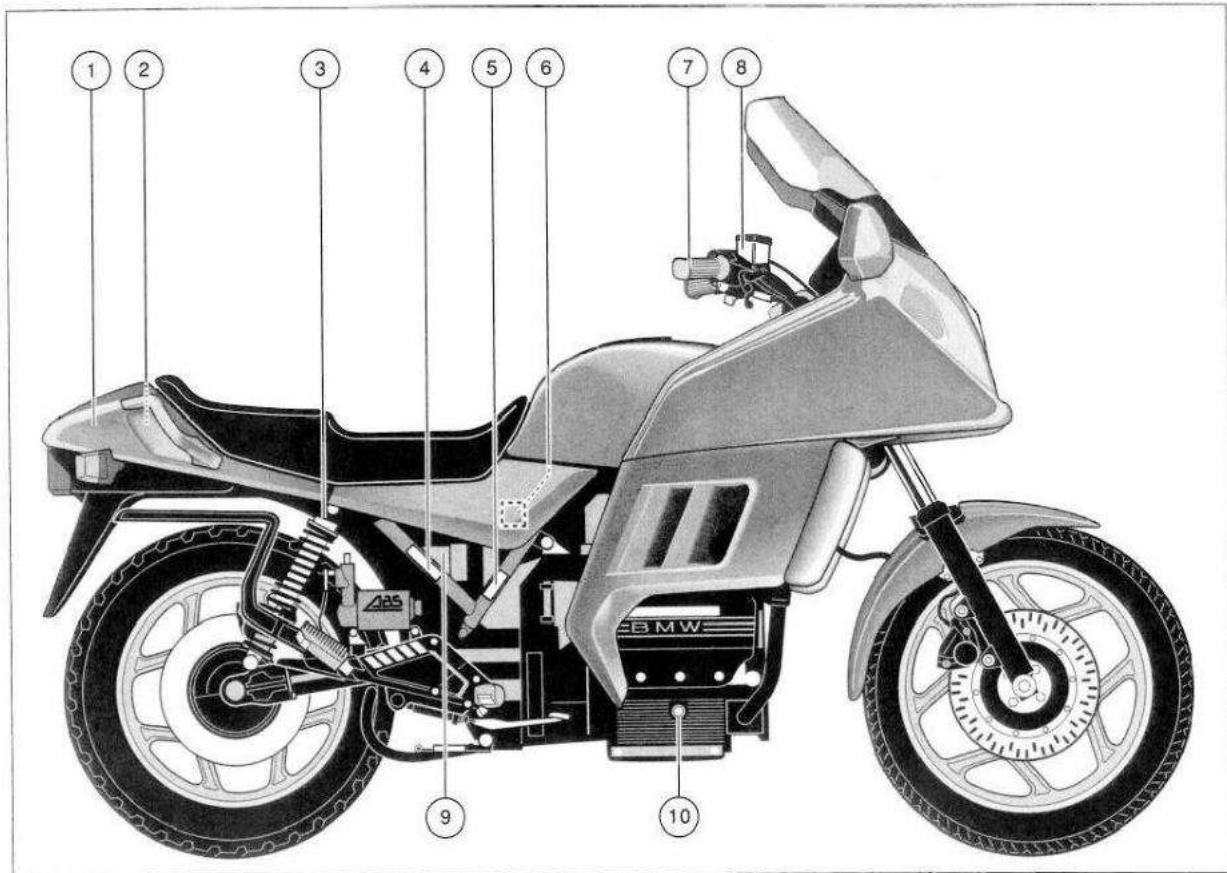

## Where is everything?

- 1 Rear storage compartment (19)
  - 2 Toolkit (48)
  - 3 Spring strut adjustment (34)
  - 4 Frame number
  - 5 Type plate
  - 6 Rear wheel brake fluid reservoir (30)
  - 7 Right handlebar controls (15)
  - 8 Front wheel brake fluid reservoir (30)
  - 9 Coolant tank (29)
  - 10 Oil level sight glass (27)
- ( ) Figures in brackets ⇒ Page on which item is described

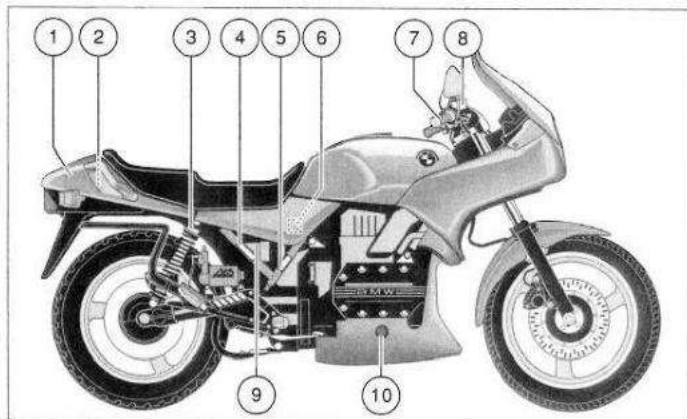
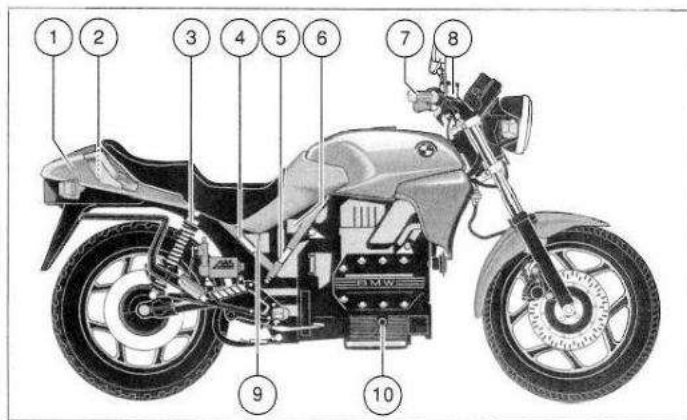

## How does it work?

### Operating instructions

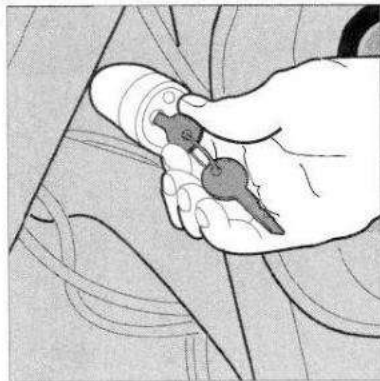
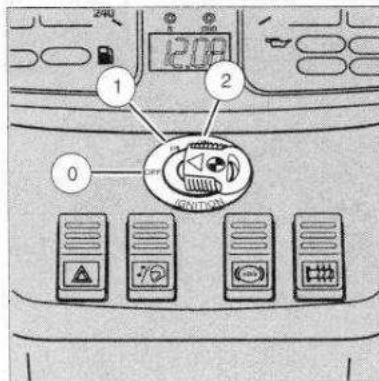

#### Keys to motorcycle

The ignition, fuel filler and storage compartments have identical locks.

1 folding head master key and 2 rigid head spare keys are supplied.

A self adhesive label bearing the key number is also supplied. Keep it in a safe place.

#### Ignition switch

- 0 Ignition off.  
Key can be withdrawn.
- 1 Parking lights on.  
Key can be withdrawn
- 2 On position.  
Ignition and all other equipment can be operated, automatic switch-on of headlight and taillight.  
Key can not be removed.

#### Note

Do not leave the parking lights on for more than a short period. Ensure that the battery is always properly charged.

#### Engaging steering lock

- Insert the key in the steering lock and turn counterclockwise.
- Turn the handlebar slightly to the right until the lock can be pushed in with the key.
- Turn the key clockwise and engage the lock.
- Remove the key.

#### Caution

Do not leave the key in the lock when not engaged, as it could become broken.

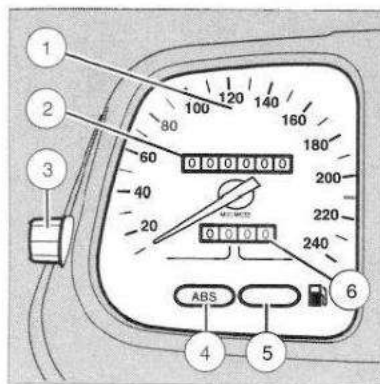

### Left instrument unit

- 1 Speedometer
- 2 Odometer
- 3 Knob for resetting trip odometer
- 4 ABS warning light  
**Red** (page 22)
- 5 Fuel level warning light  
**Red** if approximately 1.3 U.S. gal.  
(5 liters) of fuel in tank
- 6 Trip odometer

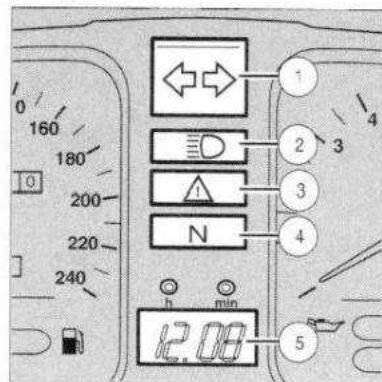

### Central instrument unit

- 1 Turn-signal telltale  
**Green**
- 2 High beam telltale  
**Blue**
- 3 Rear light monitor and ABS telltale  
**Red** (page 40)
- 4 Neutral/gearbox telltale  
**Green**
- 5 LCD Digital clock  
Setting (page 12)

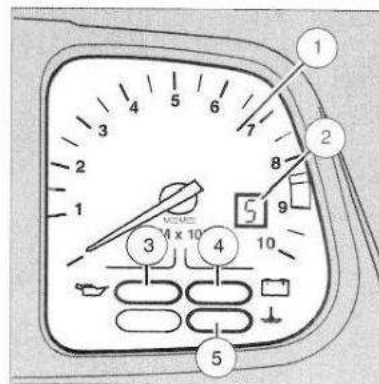

### Right instrument unit

- 1 Tachometer
- 2 Digital gear display
- 3 Engine oil pressure warning light  
**Red** (page 27)
- 4 Alternator warning light  
**Red** (page 40)
- 5 Coolant temperature warning light  
**Red** (page 40)

### Note

Telltale and warning lights should come on in ignition switch position 2 prior to starting engine.

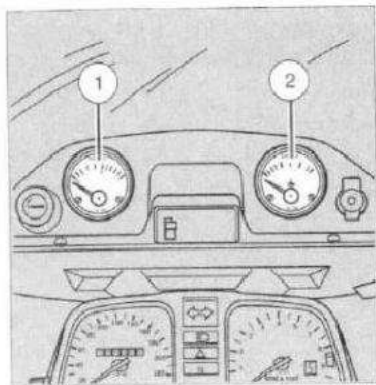

K 75 RT

### Auxiliary instruments K 75 RT

- 1 Fuel gauge
- 2 Temperature gauge

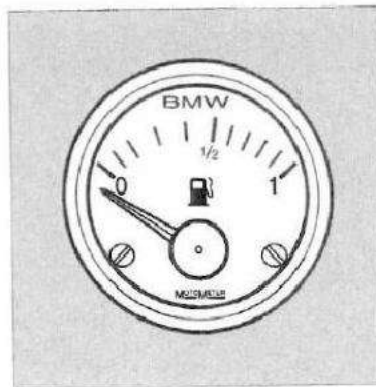

K 75 RT

### Fuel gauge

Fuel tank capacity:  
19,5 liters (5,2 gal) fuel.

#### Note

The fuel gauge only functions when the ignition is switched on (see page 28).

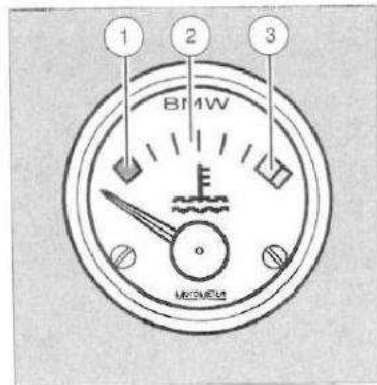



K 75 RT

### Temperature gauge

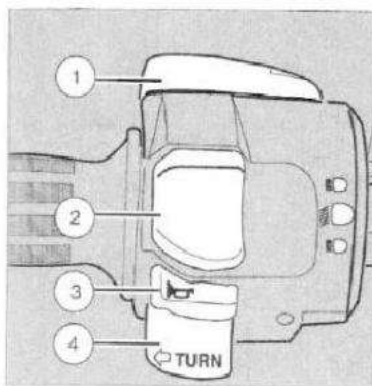
- 1 Engine cold (blue area)
- 2 Engine at operating temperature
- 3 Engine overheating (red area)  
(see page 40)



### Left handlebar controls

- 1 Choke control for cold start (page 42)
- 2 Headlight dipswitch:
  -  high beam
  -  low beam
  -  headlight flasher
- 3 Horn control
- 4 Left turn-signal switch  
Pressed:  
Left turn-signal flashes

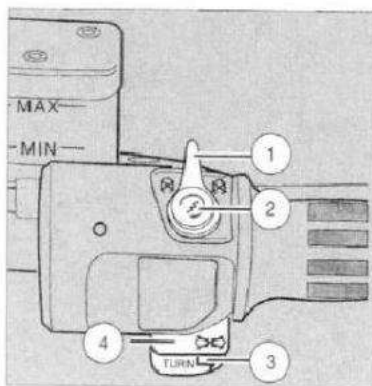

### Right handlebar controls

- 1 Ignition kill switch  
Center position:  
All electrical circuits energized when ignition on
- 2 Starter pushbutton
- 3 Right turn-signal switch  
Pressed:  
Right turn-signal flashes
- 4 Turn-signal cancel switch  
Pressed:  
Left/right turn-signal off

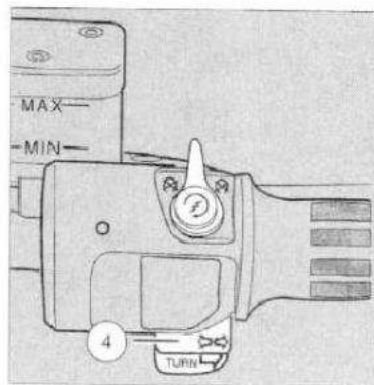

### Self cancelling turn-signals

The left or right turn indicator are cancelled automatically after a certain time or distance if this not done by pressing switch "4":

- After approximately 10 seconds at road speeds - above approximately 30 miles per hour (50 km/h)
- After approximately 210 m (690 ft) in local or slow-moving traffic.



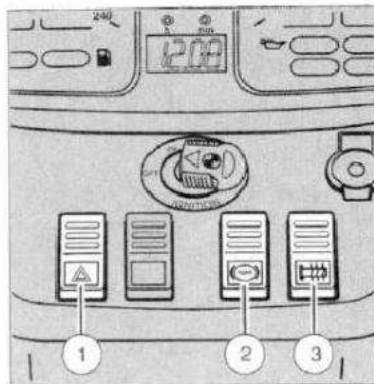

K 75

### Operating the hazard warning flashers

- Switch on ignition.
- Operate switch (1);
  - Hazard warning flashers come on.
- Switch off ignition.
  - Hazard warning flashers remain on.

### Switching off hazard warning flashers

- Operate switch (1) for hazard warning flashers.

#### Note

When the ignition is switched off, the hazard warning flashers cannot be switched on.

Only leave the hazard warning flashers on for a limited period of time.

Note battery charge.

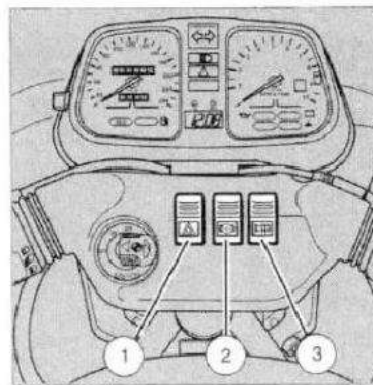

K 75 S

### ABS switch

ABS cancel button (2).

See ABS operating instructions for function, (page 22).

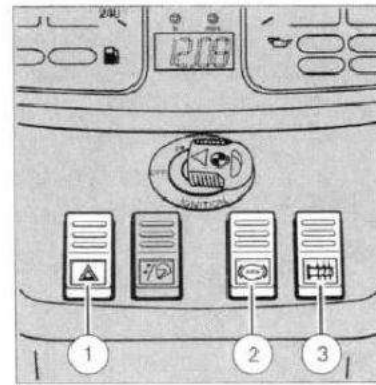

K 75 RT

### Switching on heated handlebar grips

(optional extra)

- Switch on ignition.
- Operate rocker switch (3):
 

1st stage	50 % heat output.
2nd stage	100 % heat output.

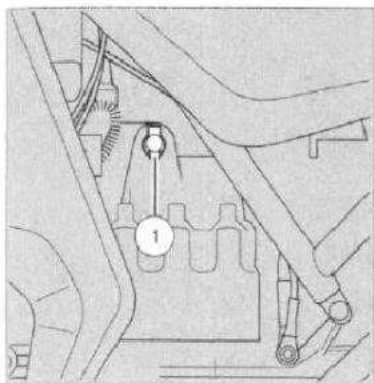

## Power sockets

### Plug sockets for auxiliary equipment

1 Socket in ignition coil holder, on left behind battery cover.

– Protected by 15 Amp fuse (fuse No. 4)

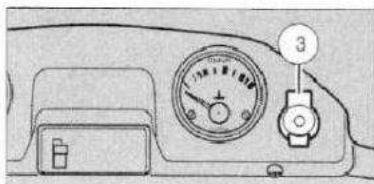
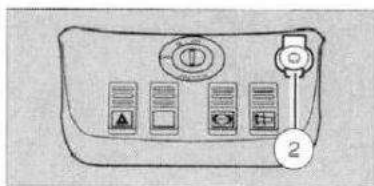

2 Right socket next to ignition switch/steering lock (K 75).

3 Right socket next to auxiliary temperature gauge (K 75 RT)

– Protected by 15 Amp fuse (fuse No. 4)

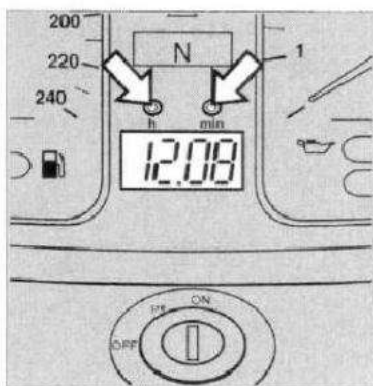

## LCD Digital clock

### Setting to correct time

- Use a ballpoint pen tip or similar item to press in the appropriate button (h/min).

h For setting hours.

min For setting minutes.

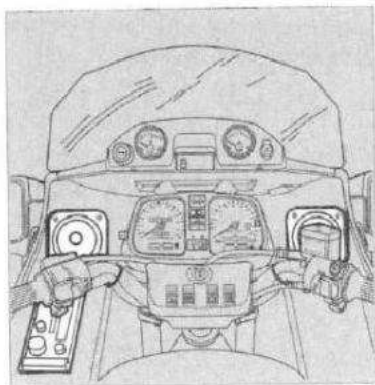

K 75 RT

### Radio

- Turn ignition key to "ON" or "R".
- Switch on Radio.  
See separate radio operating instructions, located in document pouch.

#### Caution

Operation of the radio must not be allowed to distract or disturb either the rider or other road users in any way which could create a traffic hazard or cause obstruction.

#### Note

Radio anti-theft code must be reset if battery is disconnected.



K 75 RT

### Adjusting windshield

- Switch on Ignition.
- Press switch (1).
- Windshield (2) is raised or lowered.

#### Caution

Do not adjust the windshield while riding. The windshield may only be adjusted when the motorcycle is stationary.

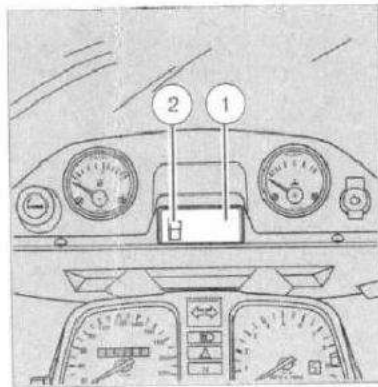

K 75 RT

### Reading lamp

- 1 Reading lamp
- 2 Reading lamp switch

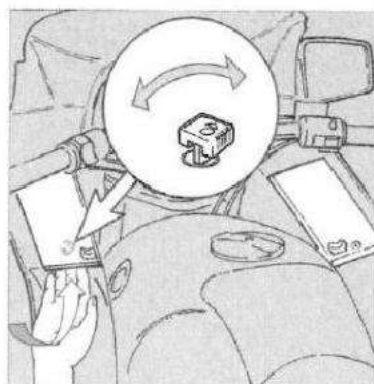
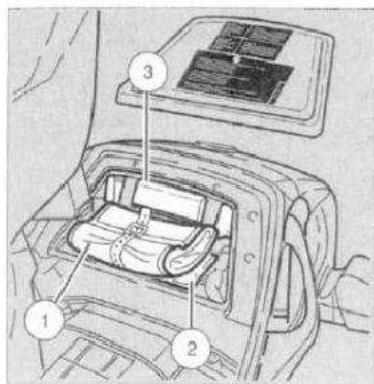

K 75 RT

## Storage compartments

### Rear storage compartment

- Open the dualseat (see Page 19).
- Take the cover off the rear storage compartment.
- Storage space for:
  - toolkit (1)
  - motorcycle documents (2)
- integrated into storage compartment: electronic ABS control unit (3) – see page 23.

### Side fairings on right

- Open storage compartment lid with the ignition key.
- Actuate the release hoop (arrow) with the fingertips.
  - Lid will jump open.
- Remove the lid to the rear
  - Storage compartment is now open.

### Note

When closing the storage compartment lid, ensure that the guide pins engage in the grooves.

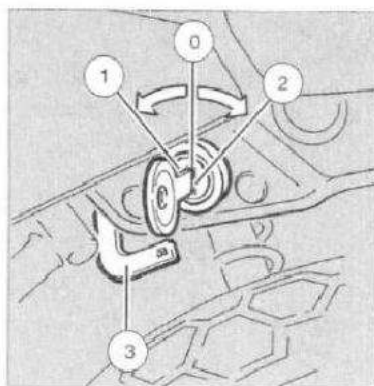

## Releasing dualseat lock/ Helmet holder

### In key positions:

- 0 The dualseat is locked.
- 1 Press in the lock.  
The dualseat is unlocked and can be opened.  
The key can be withdrawn.
- 2 Press in the lock.  
The helmet holder (3) opens.

The dualseat and helmet holder can be locked again when the key is withdrawn.

### Warning:

Do not operate motorcycle with helmet attached to helmet holder, as interference with the rear wheel could occur.

## What ABS Means on the Road

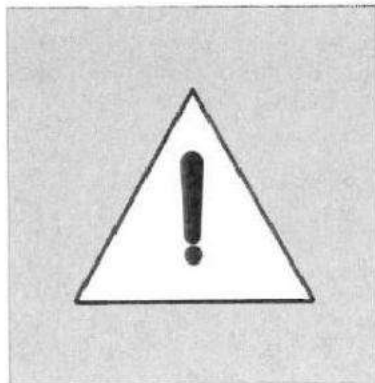
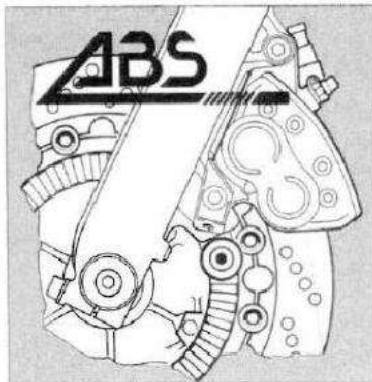

### Man and Technology: Both Have Their Limits

Every BMW has a brake system designed for the motorcycle's performance capabilities. However, the efficiency of any brake system depends not only on its technical capabilities, but also on the rider.

Balanced, well-trained responses are required to master extreme braking manoeuvres on a motorcycle. Overreaction will cause the front wheel to lock, and the resultant loss of longitudinal and lateral adhesion can easily lead to a situation in which even an experienced professional rider will not be able to avoid "laying it down".

This is why emergency braking on a motorcycle is seldom synonymous with application of maximum braking force.

Antilock braking at both wheels helps prevent falls while substantially reducing stopping distances.

ABS is particularly effective in ensuring safe emergency stops in a straight line.

It allows every BMW rider to brake like an experienced professional.

Through its very concept, the motorcycle also limits the potential of an anti-lock braking system. Applying the brakes forcefully while cornering will make the motorcycle straighten from its inclined position, thereby reducing lateral stability. Not even ABS can change this. For physical reasons, even a motorcycle with ABS loses its steering and directional potential when applying the brakes in a corner.

#### Conclusion:

**BMW motorcycle ABS adds a dimension to riding never before available. However, every rider, no matter what the level of experience, should know and understand how ABS works. Even a motorcycle equipped with anti-lock brakes requires a proper style of riding and skilful application of the brakes. Please remember that, as remarkable as ABS is, there is no substitute for safe riding practices.**

## Anti-lock Braking System (ABS)

### Notes on operating

The speed of the wheels is constantly monitored by the pulse generating wheels (1) and sensors (2); this information is then transmitted to the electronic control unit (3). If there is a risk of either wheel locking during the braking process as a result of reduced surface grip or excessive braking force (braking pressure), the electronic control device activates the pressure modulators (4). The appropriate pressure modulator reduces the hydraulic pressure in the brake caliper (5) in a fraction of a second until the risk of locking is eliminated. This process is repeated up to 7 times per second, for as long as the brake pressure at the handbrake lever and/or brake pedal (6) remains excessive.

ABS cannot add or distribute pressure from front to rear, it can only interrupt excessive pressure. Therefore, the rider must use both front and rear brake for full effect.

Braking processes are not controlled by ABS:

- at speeds below 2.5 mph (4 km/h)
- when the ignition is switched off
- when the battery is faulty or flat (in which case the ABS telltale will light up).

In all these situations, the conventional brake system will still remain operational.

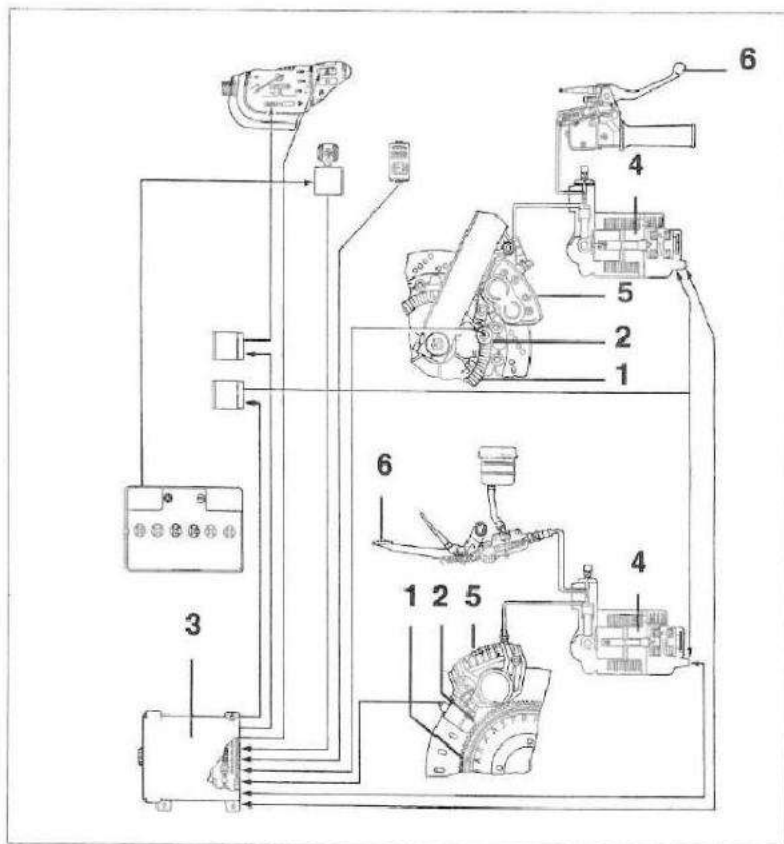

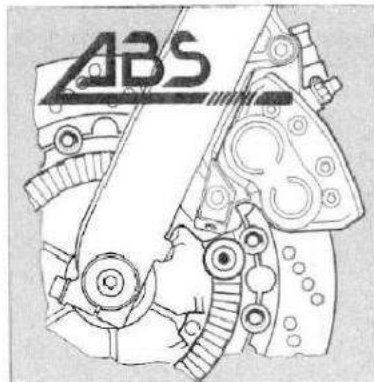
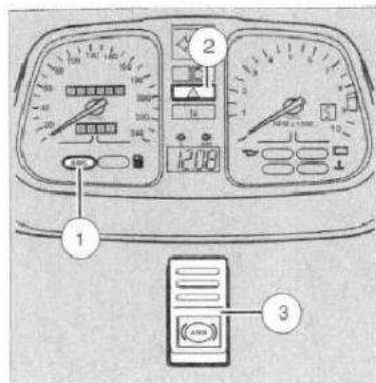

### General Operation

The ABS is energized automatically when the motorcycle ignition is turned "on", observing the following sequence:

- When the ignition is turned on, the **ABS warning light (1)** flashes.
- **The rear light monitor (2) has the double function of a second ABS warning light and will remain constantly illuminated when the ignition switch is initially turned on.**

Once the operation of the brake light is verified by actuating the front brake lever and rear brake pedal, the light monitor will flash in parallel with the ABS warning light.

- The ABS system will run through an automatic check, once the motorcycle is driven away. When all functions are confirmed, both warning lights go out when the motorcycle reaches a speed of 2.5 mph (this will seem almost immediate).
- The ABS cancel switch (3) is not used during normal operation and only serves to cancel the flashing of indicators when a fault emerges. See page 23 for fault monitoring.
- **If the ABS should detect a fault for any reason, both warning lights will flash in parallel.**
- **Once a fault is detected, you will no longer be operating with benefit of ABS.**
- **The flashing warning lights can be changed to constant illumination by depressing the cancel switch (3).**

This will make the indicator lights less annoying, especially at night. The warning lights will resume flashing after approximately 10 minutes to emphasize that you are no longer operating with the benefit of ABS. As before, you can change them from flashing to constant illumination for (approximately) 10 minute intervals by depressing the cancel switch (3). This can be repeated as many times as necessary.

#### Note

**However, please remember the difference in braking effectiveness when you are without the benefits of ABS.**

**If the ABS fails, the conventional brake system will remain operational.**

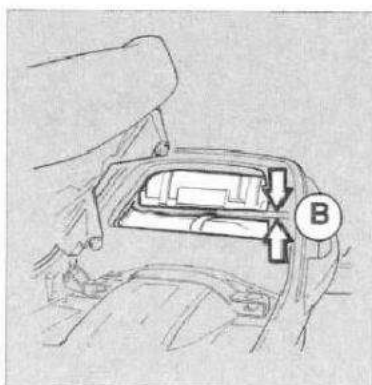

### What happens if I spin the rear wheel during acceleration?

Spinning the rear wheel may cause the ABS system to lose programmed coordination, as the front wheel is no longer synchronized with the rear wheel. This loss of coordination will cause the ABS unit to register a fault. Faults registered from wheel spins will usually cancel themselves when the ignition is turned "off". If not, you must visit your authorized BMW motorcycle dealer to have the control unit "reset". Until the "reset" is performed, you will not be operating with the benefits of ABS.

### Electronic ABS control unit

The control unit is housed in the rear section of the dualseat and isolated against vibration.

#### Note:

**When storing items in the compartment, free movement (B) of the control unit must not be obstructed, to prevent electronic component faults caused by the transmission of vibration.**

#### Important:

**In the event of faults to the ABS or brake system, allow an authorized BMW motorcycle dealer to repair the motorcycle as soon as possible.**

#### Caution:

While it is well protected, the electronic control unit can only withstand a certain electromagnetic load.

You are therefore advised against using high-performance radio equipment on the motorcycle, as the ABS may otherwise suffer from interference.

When working on the electrical system, always switch off the ignition and disconnect the battery negative lead.



# Safety check

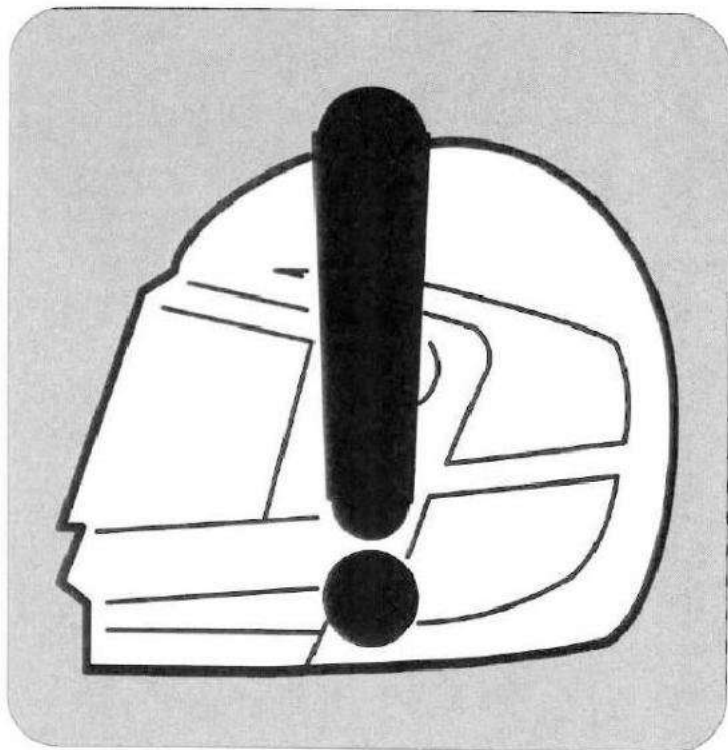

## Safety checks before you start

- General note (26)
- High performance ignition system (26)
- Engine oil level (27)
- Add engine oil (27)
- Engine oil pressure (27)
- Fuel level (28)
- Adding fuel (28)
- Coolant level (29)
- Correcting coolant level (29)
- Brake fluid level (30)
- Topping up brake fluid (31)
- Brake pedal travel (32)
- Handbrake lever travel (32)
- Clutch level travel (32)
- Tire pressures (33)
- Tire tread depth (33)
- Rims / valve caps (33)
- Spring strut setting/Damping (34)
- Side stand (34)
- Loads (35)
- Lighting (35, 36)

( ) Figures in brackets ⇒ Page on which item is described.

## Safety checks before you start

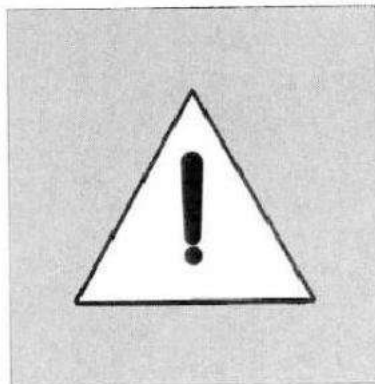

### General note

Perform the safety checks conscientiously. This allows you to rectify any faults on your motorcycle before you set off (refer to care and maintenance from page 45 on), or to have them rectified at your BMW motorcycle dealer.

Only a motorcycle which is in proper working order assures your own safety and the safety of other road users.

If you have any problems or difficulties, contact your BMW motorcycle dealer which will be able to provide you with professional advice.

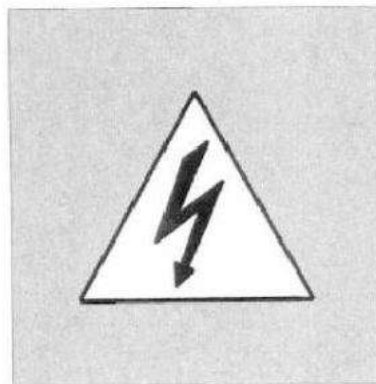

### High performance ignition system

Even on conventional ignition systems with breaker points, an electrical shock could be quite unpleasant.

**On this motorcycle's ignition system, however, much greater care has to be taken.**

**The motorcycle is equipped with a micro-processor-controlled high-performance digital ignition system.**

#### Warning:

**A dangerous or even fatal accident could be caused by touching any live component while the engine is running**

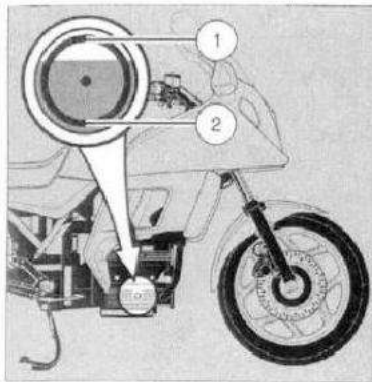

## Engine oil level

### Checking

- Position motorcycle on its center stand on a flat, level surface.
- Run the engine for a short time and then switch it off.
- Check the oil level reading after a few minutes at the ring marking.  
maximum level (1)  
minimum level (2)  
Capacities between Minimum/Maximum marks:  
approximately 0.6 liters (1.05 pints)

### Caution

Always ensure oil level is not above Maximum and not below Minimum mark! Damage to engine may occur!

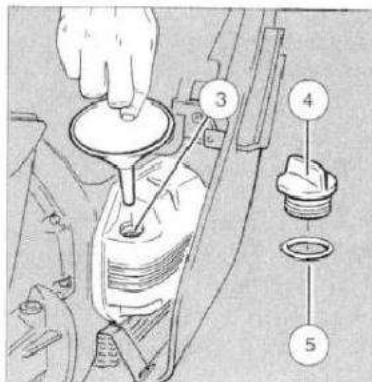

## Add engine oil

- Pour in engine oil through funnel into filler opening (3). (Refer to page 74 for oil grades).
- Screw in oil filler plug (4) with seal (5).
- Run engine briefly/switch off.
- Check oil level after a few minutes at oil sight glass.

### Note

A full range of BMW Special Performance lubricants is available from your authorized BMW motorcycle dealer.

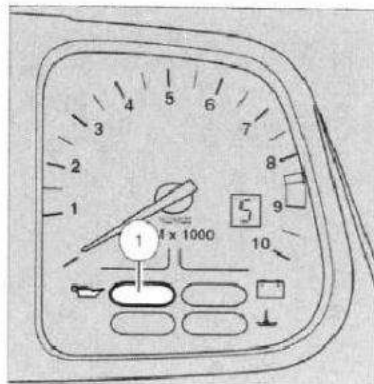

## Engine oil pressure

Telltale light (1) out

- After engine starts.
- At idling speed.

### Caution

If telltale light lights up when riding, immediately:

- disengage clutch
- switch off ignition
- bring motorcycle safely to a stop
- check engine oil level

If there is enough oil in the engine, contact your BMW motorcycle dealer or qualified service technician.

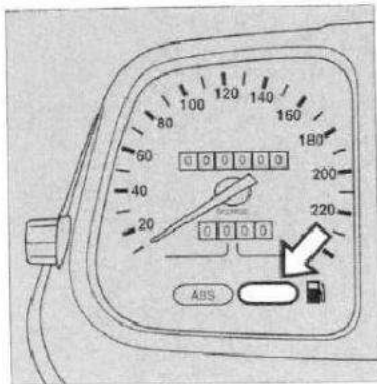

### Fuel level

The low fuel warning light (arrow) comes on when approximately 5 liters (1.3 gal.) of fuel remain in the tank.

The fuel tank holds a total of 19.5 liters (5.2 gal.). After the motorcycle has been broken in, determine how far it can normally be ridden with the low-level light on (this will depend on your riding style).

#### Warning:

Gasoline is extremely flammable and is explosive under certain conditions. Refuel in a well-ventilated area with the engine stopped. Do not smoke or allow flames or sparks in the area where the motorcycle is refueled or stored. Never use an exposed flame to check fuel level! Do not overfill the tank (there should be no fuel in the filler neck). After refueling, make sure the tank cap is closed securely. Fuels containing ethanol or other oxygenates (e.g. ethers and ketones) or methanol may cause drivability, starting and stalling problems. Fuel additives are not recommended.

#### Caution:

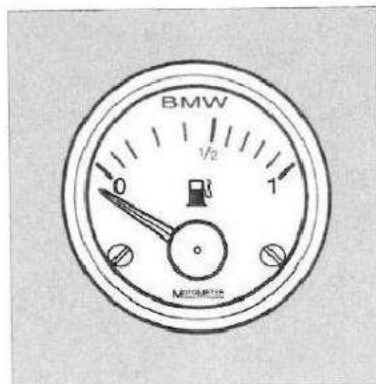

### Fuel gauge

Fuel tank capacity:  
19,5 liters (5.2 gal) fuel.

#### Note

The fuel gauge only functions when the ignition is switched on.

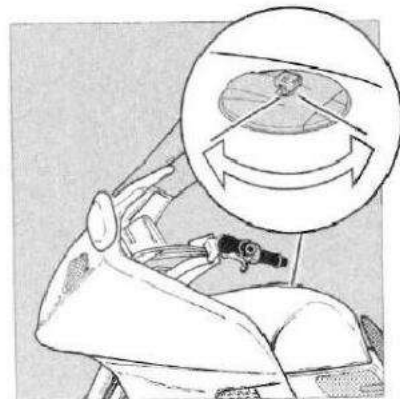

### Adding fuel

#### Warning:

Turn your head from fuel cap when opening. Fuel tank operates under a low pressure.

Unlock the filler cap (all locks on motorcycle can be opened with the same key).

- Insert key.
- Turn counterclockwise  $1/4$  revolution.
- Cap springs up automatically, the key can be removed.
- After adding fuel, ensure that the cap is closed securely by pushing the cap down until a "click" is heard to lock it.

#### Note:

Use only middle or premium grade unleaded fuel, minimum octane number 89 (Anti-knock Index  $R+M/2$ ) or minimum octane number 95 (Research Method, RM).

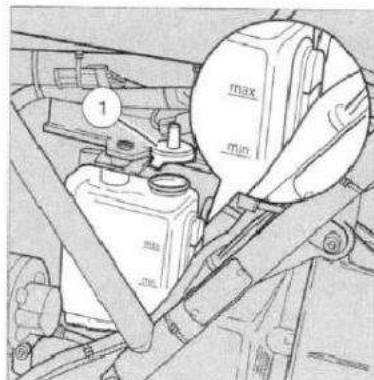
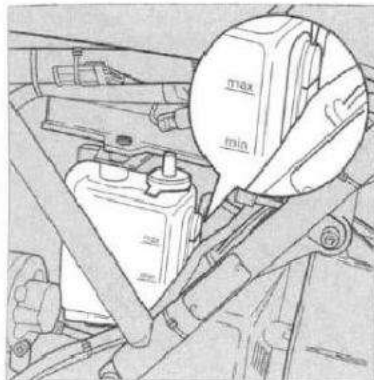

## Coolant level

### Checking

- Engine cold.
- Place motorcycle on center stand.
- Remove the battery cover on the right.
- Read off coolant level at expansion tank (arrow).
- Add coolant, if necessary, up to bottom of filler neck.

### Caution

If the coolant temperature warning lamp (red) comes on, check coolant level in expansion tank immediately (see above).

## Correcting coolant level

### Procedure

- Place motorcycle on center stand.
- Take off the right battery cover (see page 70).
- Remove the filler cap.
- Top up with coolant mixture as far as the "MAX" mark.
- Put the filler cap back on.

### Caution

If expansion tank is full and warning lamp is still on or you have excessive coolant consumption, contact your BMW motorcycle dealer or qualified service technician. Operation with an overheated engine may cause damage to the engine.

### Note

Correct coolant level only when engine is cold.

Refill at expansion tank when there is a slight loss of coolant.

### Mixing ratio:

- 40% antifreeze,
- 60% water.

Provides antifreeze protection down to:  
- 26 °C (-8 °F)

Have coolant replaced every two years regardless of mileage.

Nitrite-free BMW Coolant is available from your authorized BMW motorcycle dealer.

### Caution

Use only antifreeze and anti-corrosion agents free of nitrite!

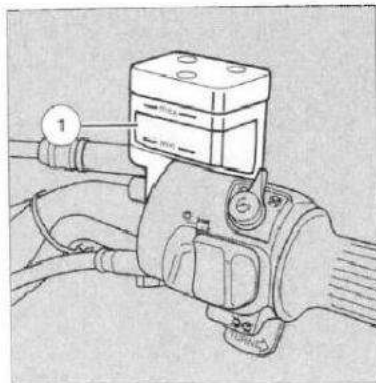

### Brake fluid level

#### Checking: Front wheel brake

- Turn steering to left.
- Check brake fluid level at transparent reservoir (1).
- Note "MIN/MAX" marks.
- If necessary, add brake fluid up to "MAX" mark (see page 31).

#### Caution

**Do not allow fluid to drop below Minimum level! Fluid must be visible in sight glass!**

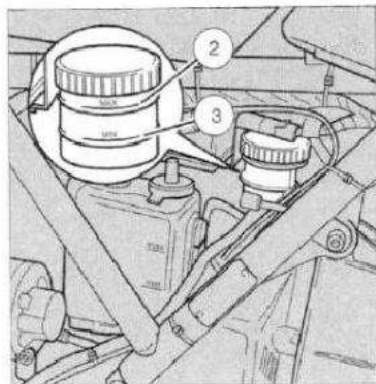

#### Checking: Rear wheel brake

- Remove the right battery cover.
- Take reading of brake fluid level at MAX/ MIN markings.

#### Maximum level (2)

#### Minimum level (3)

- Top up brake fluid up to MAX marking, if necessary. Refer to page 31 for topping up.

#### Caution

**Do not allow fluid to drop below Minimum level!**



### Brakes

**Before starting any trip, always test the brakes:**

- the hydraulic brake circuit is intact if the brake lever can be operated without a 'spongy' feeling.
- there must be sufficient brake fluid in the front reservoir.
- brake discs and calipers must be free from oil, grease and traces of solvents or cleansers.

#### Warning:

**Never ride your motorcycle if you are in any doubt as to the condition of the brakes.**

**Check with your BMW motorcycle dealer or qualified service technician immediately.**

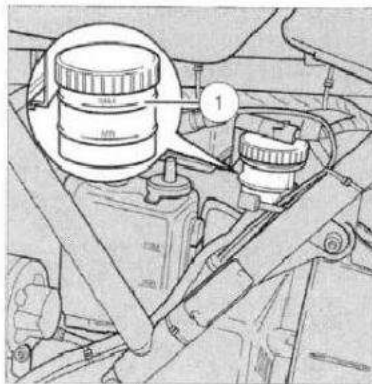
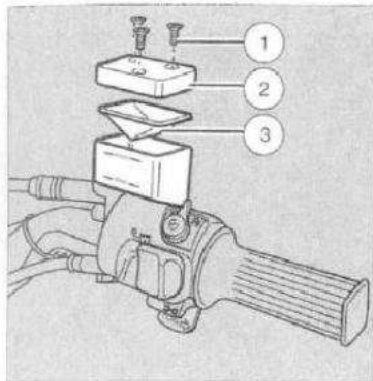

## Topping up brake fluid

### Front wheel brake

#### Tools required

Screwdriver with reversible blade.

#### Procedure

- Unscrew 3 phillips screws (1) (press cover down when doing this).
- Turn handlebars fully to the left. Take off cover (2) and rubber membrane (3).
- Top up brake fluid to upper edge of sight glass.
- Fit on rubber membrane and cover.
- Press on cover, turn handlebars fully to the right. Tighten phillips screws gently.

#### Warning:

Steam cleaning of the hydraulic brake system can affect brake fluid viscosity and is not recommended.

### Rear wheel brake

#### Procedure

- Take off the right battery cover (see page 70).
- Pull reservoir out of fixing clamp.
- Take off cover with rubber membrane.
- Top up brake fluid to MAX mark (1).
- Install in the reverse order.

### Caution

Use only fresh brake fluid conforming to specification DOT 4.

Brake fluid may cause damage to paint-work!

Brake fluid is subject to high thermal stresses and absorbs moisture from the surrounding air.

For this reason:

Regardless of the distance you have covered, brake fluid should be replaced at least once a year.

In areas with mainly high temperatures and/or high air humidity, the brake fluid has to be replaced at least every 6 months.

#### Note

BMW (DOT 4) Brake Fluid is available from your authorized BMW motorcycle dealer.

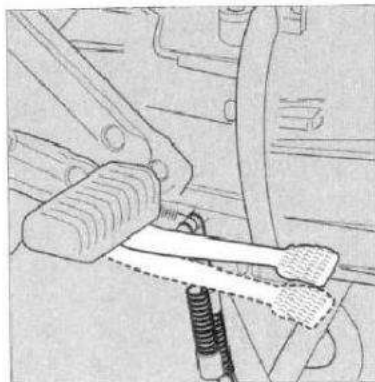

### Brake pedal travel

#### Checking

The brake pedal travel is factory set and must not be altered.

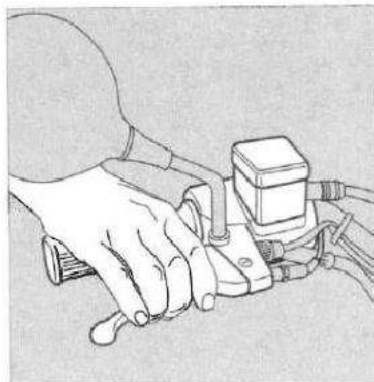

### Handbrake lever travel

#### Checking

The handbrake lever travel is a design feature and cannot be altered.

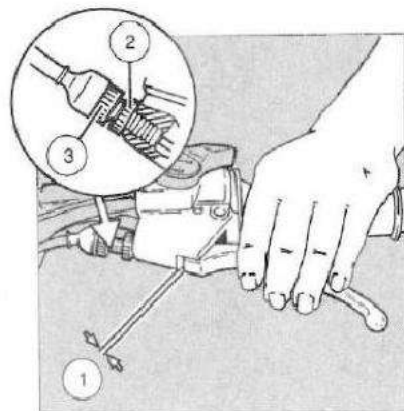

### Clutch lever travel

#### Checking

- Pull lever until resistance is felt.
- Measure free travel.  
Should be (arrow):  
4 +/- 0.5 mm.
- Slacken lock nut (2).
- Turn adjusting screw (3) to the left: reduces free travel.
- Turn adjusting screw (3) to the right: increases free travel.
- Tighten lock nut (2).

#### Note

Basic clutch adjustment takes place during the BMW Inspection.

#### Warning

Independent use of only the front or rear brake reduces stopping performance. Extreme braking may cause either wheel to lock, reducing control of the motorcycle.

When possible, reduce speed or brake before entering a turn; closing the throttle or braking in midturn may cause wheel slip. Wheel slip will reduce control of the motorcycle.

When descending a long, steep grade, use engine compression braking by downshifting, with intermittent use of both brakes. Continuous brake application can overheat the brakes and reduce their effectiveness.

Sudden changes in the amount of free travel or a spongy feeling at the brake lever are signs of possible malfunctions in the hydraulic system.

Contact your BMW motorcycle dealer or qualified service technician immediately.



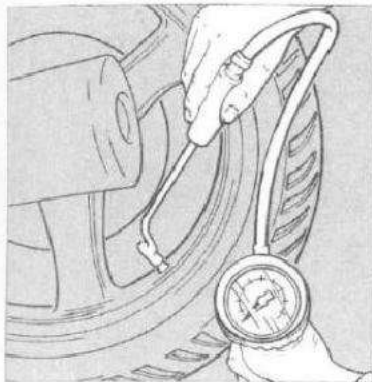

### Tire pressures

For your safety, periodically and certainly always before a trip, check your tire pressure, making sure it conforms to specifications provided below.

#### Checking

- Tires cold
  - Unscrew valve caps.
  - Check/correct tire pressure.
  - Screw on valve caps
- One-up**  
front / rear 32/36 psi (2.2/2.5 bar)
- Two-up**  
front / rear 36/42 psi (2.5/2.9 bar)

#### Warning:

Incorrect tire pressure can considerably affect the driving characteristics of the motorcycle as well as reduce tire life!

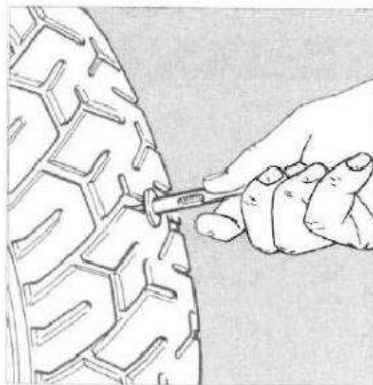

### Tread depth

#### Breaking in new tires

#### Warning

New tires have a smooth tread surface. You should therefore exercise particular care during the initial miles, waiting for the smooth factory tread surface to wear in before demanding maximum performance!

This break-in procedure is essential if the tires are to provide their full potential traction later on!

#### Checking

- Checking tire tread.

#### Warning

Comply with official requirements governing minimum tread depth!

- Measure tread depth at the center of the tire.

BMW's minimum tread depth recommendation:

Front wheel	2 mm.
Rear wheel	3 mm.

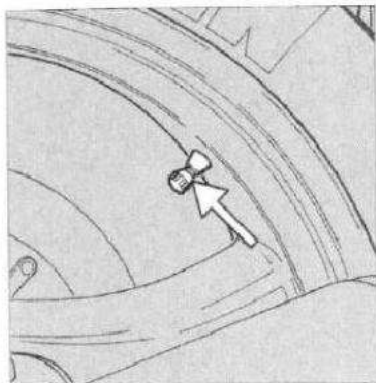

## Rims / valve caps

### Wheels

The wheels (rims) are an important safety item. Although the wheels are very strong, they could be damaged or distorted in an accident or by riding over an obstacle.

- Check that metal valve caps with seal are tightly seated on valves.

### Warning:

Damaged wheels must always be replaced. Do not straighten or repair. Check your wheels regularly for damages.

Tire valves tend to open suddenly because of centrifugal forces at high speeds! Valve caps prevent a sudden loss of tire pressure!

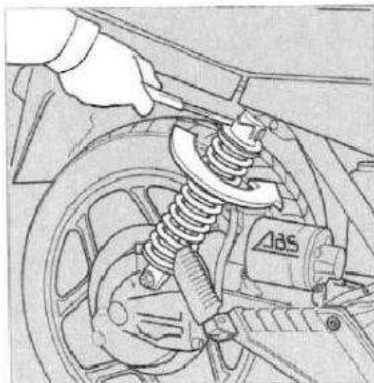

## Spring strut preload

### Adjusting spring preload:

- Adjust the spring preload of support springs to the load conditions with the aid of a spanner and extension (in motorcycle toolkit).
  - 1 "Normal" spring setting for solo operation.
  - 2 "Moderate" spring setting when riding two-up or with heavy luggage.
  - 3 "Firm" spring setting for extreme loads.

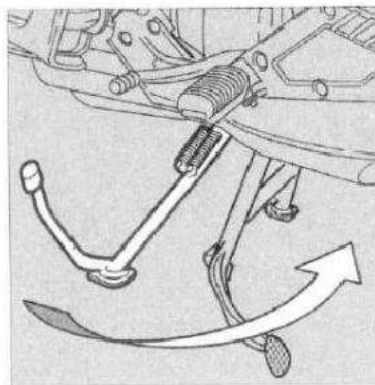

## Side stand

### Checking

- Position the motorcycle on center stand.
- Fold out sidestand as far as stop.
- Release sidestand.
  - Stand (arrow) must retract automatically by the return springs.



#### Warning

Handling and stability of your motorcycle can be adversely affected by a number of factors.

In particular, excessive or unbalanced loading and the use of accessories not approved by BMW can lead to dangerous deterioration of the handling and stability characteristics of your motorcycle and thereby cause an accident.

Maximum speed with luggage system attached:

⇒ 130 km/h (80 mph)!

Ride behavior affected at high speeds.

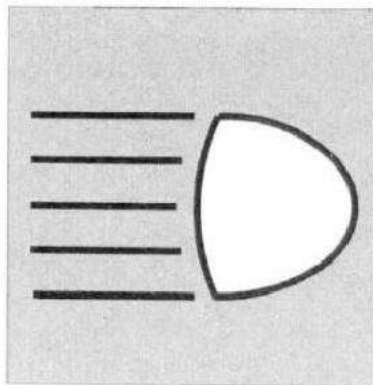

## Loads

Your motorcycle can be equipped with a specially developed luggage system.

The BMW luggage system consists of:

- Integral BMW cases
- BMW top case
- BMW tank-top rucksack

### Checking

- Do not exceed the maximum load for each case.

Maximum loads:

Per integral case (10 kg) 22 lbs  
35 litre top case ( 5 kg) 11 lbs

- Refer to system description for fitting and removing cases.
- Check that the fastenings are correctly located and tight.

#### Warning

Do not exceed these specified load limits.

Stow heavy items of luggage in the bottom area of the tank top bag (alters center of gravity!).

Always make use of both side cases.

Ensure that the weight is evenly distributed on both sides.

Do not exceed the permissible gross weight 1100 lbs (480 kg).

Permissible gross weight comprises:

- Motorcycle with full tank
- Rider
- Passenger
- Luggage
- Accessories

## Lights

Before starting the engine, it is a good practice to check the operation of the

- parking light
- low headlight beam
- high headlight beam

by holding a hand in front of the headlight lens.

As you have read on page 35, the tail and brake lights can be checked at monitor "△".

Pay special attention to condition of the turn indicators:

Turn indicator bulbs have to withstand severe loadings. A blown or damaged bulb can normally be detected by the increased flashing frequency of the turn signal telltale, and should be repaired or replaced immediately.

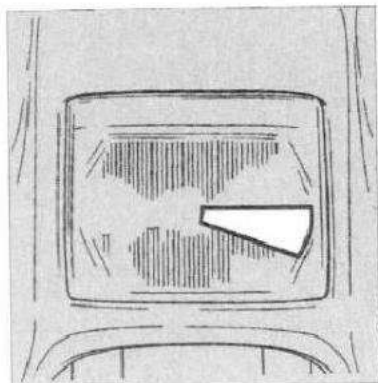

### For countries with leftside rule of the road.

Motorcycles for countries with leftside rule of the road are equipped with leftside asymmetrical low beam headlight.

The headlight beam is correctly aimed by analogy to the description on the left.

#### Note

Left cutoff point is determined by leftside asymmetrical low beam headlight.

If a motorcycle with right-hand asymmetrical low beam headlight is ridden temporarily in countries with leftside rule of the road, the wedge visible in the center of the lens must be blanked off with adhesive tape cut to shape.

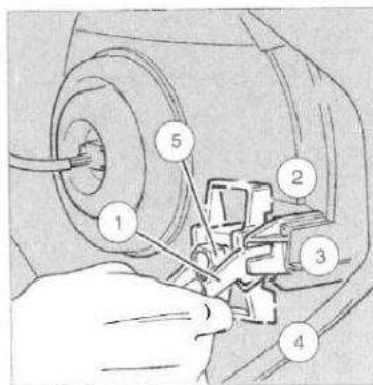

### Adjusting headlight beam angle

#### High/low setting

#### No tools required.

Set vertical beam angle of headlight by adjusting lever (1) to the right of headlight bulb, ahead of right fork tube

- Lever moved up (2):  
⇒ long beam angle.
- Lever in middle position (3):  
⇒ neutral beam angle.
- Lever in bottom position (4):  
⇒ short beam angle.

Perform fine setting with hexagon plastic screw (5).

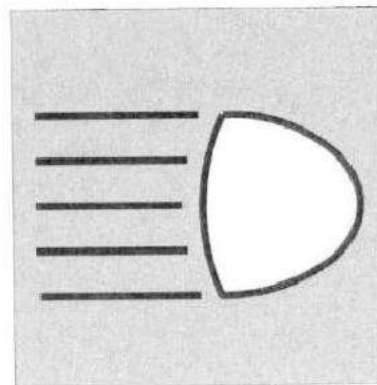

#### Note

Adjust high/low setting of beam so as not to blind oncoming traffic.

Ensure that light beam illuminates road surface sufficiently far ahead.

# Starting – Riding – Parking

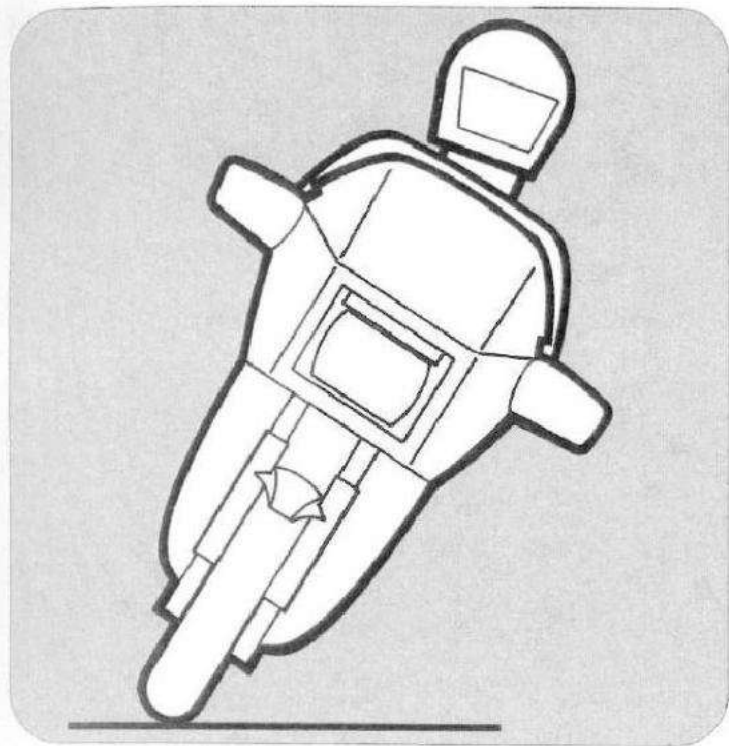

## And now we're off!

- Note on catalytic converter (38)
- Important ABS information (39)
- Some breaking-in rules (39)
- Engine speed limits (39)
- Rear light telltale (40)
- Coolant temperature (40)
- Battery charge current/alternator (40)
- Before starting the engine (41)
- Switching on ignition (41)
- Selecting neutral (41)
- Operating the choke (42)
- Pressing the starter switch (42)
- Resetting choke (42)
- Changing gears (43)
  - Moving off/shifting up (43)
  - Shifting down (43)
- Placing motorcycle on center stand (44)
- Moving motorcycle off center stand (44)
- Placing motorcycle on side stand (44)

( ) Figures in brackets ⇒ Page on which item is described.

## And now we're off! Starting – Riding – Parking

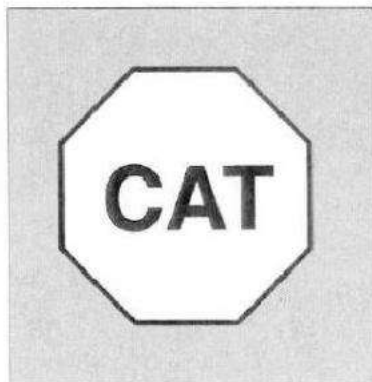

### Catalytic converter

#### Note

If the motorcycle has a catalytic converter:

Always use unleaded premium grade fuel.

Do not run the fuel tank empty.

Always have the prescribed maintenance work carried out.

If the engine misfires, switch it off immediately.

Only push-start when the engine is cold. It is preferable to use jump leads from another battery.

Do not allow the engine to run with any spark plug caps disconnected.



If the engine misfires or its power output deteriorates acutely, ride at low engine speed to the nearest authorized BMW motorcycle dealer.

#### Caution

High temperatures build up at the exhaust (with or without catalytic converter).

Make sure that no easily combustible material (for example hay, leaves, grass etc.) comes into contact with the hot exhaust system when the motorcycle is being ridden, idling or parked.

If this material were to ignite and cause a fire, very serious injuries or damage could result.

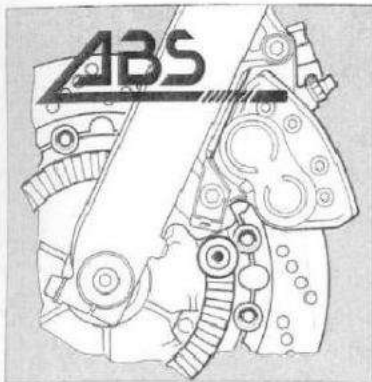

#### Caution

A motorcycle fitted with ABS should not be accelerated if the rear wheel is spinning to a considerable degree, as this results in a disparity between the wheel speed and the actual road speed.

If the brakes are applied immediately afterwards in this situation or the twist-grip turned back suddenly, the rear wheel decelerates rapidly. In extreme cases, the ABS system could interpret this as an emergency brake application and the system could be activated, delaying the build-up of brake pressure at the rear wheel for a brief period of max. 1 second.

The front brake remains under full ABS control regardless of this.



#### Some breaking-in rules

Carefully breaking-in your motorcycle can make a positive contribution to performance and operating life. For this reason, please pay close attention to the breaking-in rules and engine speed limits given below.

While breaking-in your motorcycle, frequently vary engine load and speed. Breaking-in is ideally carried out on roads with plenty of curves and hills, rather than highways.

Avoid, if possible, full brake applications until after the first 500 km (300 miles).

Break-in the tires for at least 500 km (300 miles), gradually increasing lean angles to wear off tire coatings.

Remember to have the first inspection performed after 1000 km (600 miles).

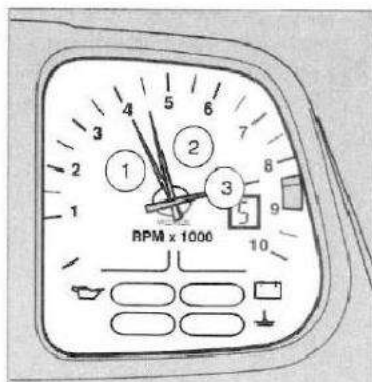

#### Engine speed limits

0 to 1000 km (600 miles)

max. 4000 rpm (1)

1000 to 2000 km (600 1200 miles)

max. 4500 rpm (2)

After 2000 km (1200 miles)

max. 8700 rpm (3)

#### Caution

Exceeding maximum engine speeds increases engine wear!

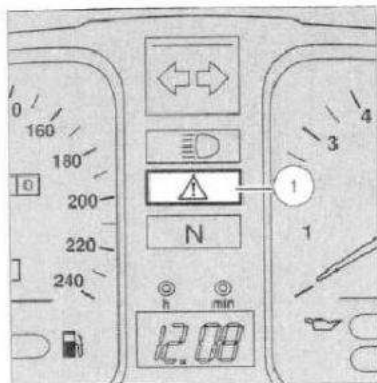

### Rear light telltale

#### Checking

- Switch on ignition, parking lights/headlight. Light monitor will illuminate.
- Operate handbrake and brake pedal.
  - Telltale light (1) changes to flashing: Tail and brake light operating.
  - Telltale light does not flash: Bulb, wiring or switch faulty.
  - Telltale lights up when riding: Fault in tail light.

A tail light fault can only be detected when the parking lights or headlight are on.

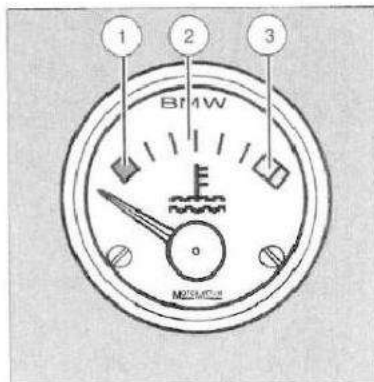

### Coolant temperature gauge

- 1 Engine cold (blue area): ride at low engine speeds.
- 2 Engine at operating temperature.
- 3 Engine overheating (red area): switch off immediately and allow to cool down, then contact your authorized BMW motorcycle dealer or qualified service technician.

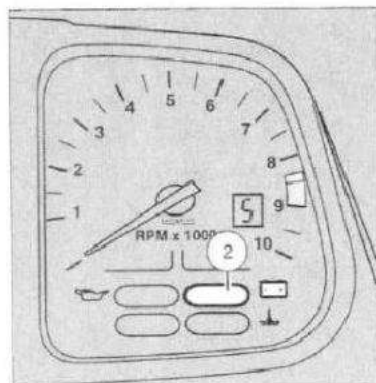

### Charge current/Alternator

Telltale light (2) goes out:

- after engine starts.
- at idling speed.

#### Note

If telltale light comes on while riding:  
Contact your BMW motorcycle dealer or qualified service technician.  
Battery will discharge quickly without input from the alternator.



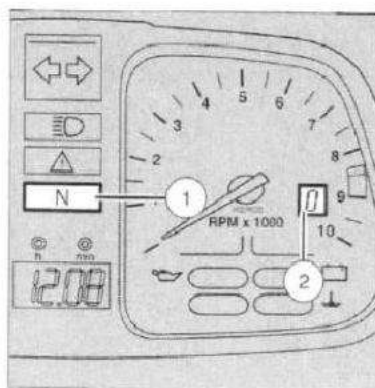
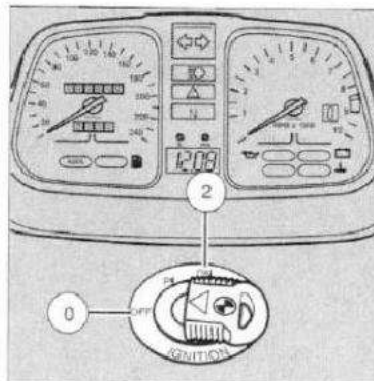
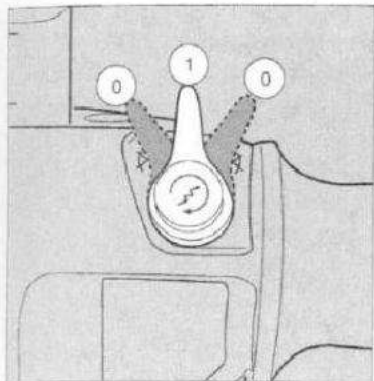

### Before starting the engine

- Place motorcycle on center stand.
- Check that the ignition kill switch is in position (1).

#### Note

Engine can only be started when kill switch is in position (1).

Ignition kill switch in positions (0):

Electrical circuits for ignition, injection system, fuel pump and starter are de-energized.

Emergency stop:

Move switch into position (0).

### Switching on ignition

- Use ignition key to turn ignition lock into On position (2).

### Selecting neutral

- Neutral telltale light (1) comes on.
- Digital gear display (2) in position ("0").

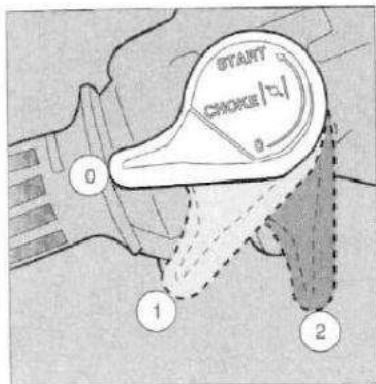

### Operating choke (increased cold starting speed)

Operate choke lever depending on engine or ambient temperature.

- Position 2 :  
below 32 °F (0 °C).
- Position 1 :  
above 32 °F (0 °C).
- Position 0 :  
engine at normal operating temperature.

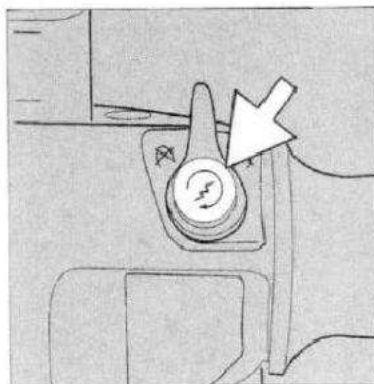

### Pressing starter switch

- Engine starts.
- If necessary, rotate throttle-twist grip gently.
- Pull-in clutch lever when starting engine at ambient temperatures below 32 °F (0 °C).

#### Note

Attempting to start engine with a low battery will cause starter relay to chatter audibly. Further attempts at starting will damage starter relay.  
Charge battery!

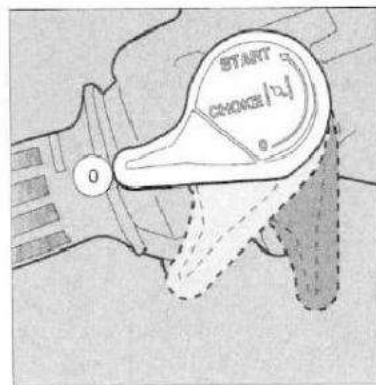

### Resetting choke (increased cold starting speed)

As engine runs more smoothly

- Move gradually back to position (0).

#### Note

Do not run engine at fast speeds for too long.

Move back choke lever as soon as possible.

Do not warm up engine at idling speed. Move off immediately after starting.

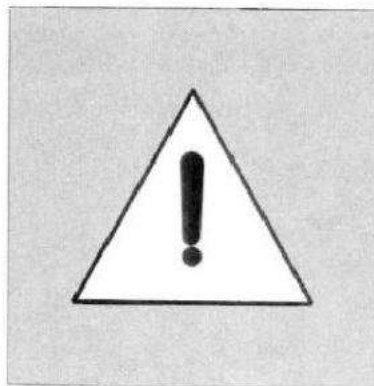
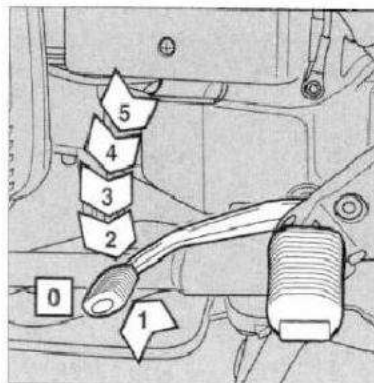
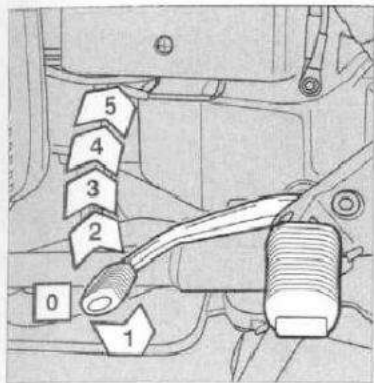

## Changing gears

### Moving off/shifting up

- Pull clutch lever.
- Press gear change pedal down fully.
- Engage clutch smoothly.
- Increase engine speed slightly when engaging clutch.
- After clutch engaged, accelerate.
- Similar procedure for shifting up into 2nd, 3rd, 4th and 5th gear.

### Caution

Do not allow clutch to slip when changing gears. Vary speed only with the throttle. Otherwise clutch may wear prematurely.

### Shifting down

- Close throttle twist grip.
- Pull clutch lever.
- Shift down into next lower gear.
- Engage clutch again slowly.
- After clutch engaged, accelerate.

### Note

Alter throttle opening to reduce the jerk caused by selecting lower gear.

Digital gear display in revolution counter indicates gear selected.

Select a lower gear if engine speed drops below 1500 rpm during normal riding.

### Warning:

When riding in wet or rainy conditions, or on loose surfaces, the ability to maneuver and stop will be reduced. All of your actions should be smooth under these conditions. Intentional sudden acceleration, braking, or turning may cause loss of control. For your safety, exercise extreme caution when braking, accelerating or turning.



### Placing motorcycle on center stand

#### Warning:

To ensure safety, always retract both the center support and the kickstand before starting!

- Left hand on left handlebar twist grip.
- Right hand on retracting handle below seat edge.
- Right foot on arm of center stand.
- Transfer full body weight onto center stand arm.
- Pull motorcycle up and back onto center stand (arrow).
- Check that motorcycle is firmly supported.

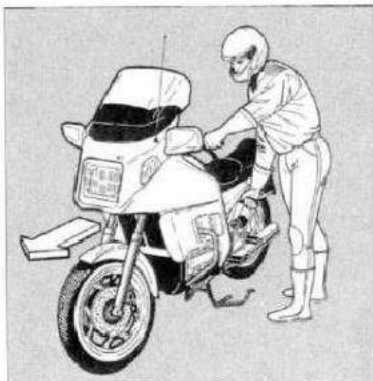

### Lowering motorcycle down off center stand

- Left hand on left handlebar twist grip.
- Right hand on retracting handle below seat edge.
- Push motorcycle forward off center stand (arrow).
- Check that center stand is fully retracted.

#### Caution

Always ensure that the stand is resting on a firm level surface, to avoid the risk of the motorcycle falling over.

#### Warning:

Center stand must be fully retracted before setting off, or an accident may result.



### Placing motorcycle on side stand

- Left hand on left handle bar twist grip.
- Right hand on dual seat.
- Extend side stand fully forward by means of its extension arm.
- Tilt motorcycle slowly onto stand.

#### Caution

Make sure the stand is always resting on a firm surface with front fork extended, to avoid the risk of the motorcycle falling over.

On an incline, always position front of motorcycle pointing uphill with sufficient lean angle toward stand and engage 1st gear to prevent motorcycle from moving

#### Warning:

Side stand must be fully retracted before setting off, or an accident may result.

# Care and maintenance

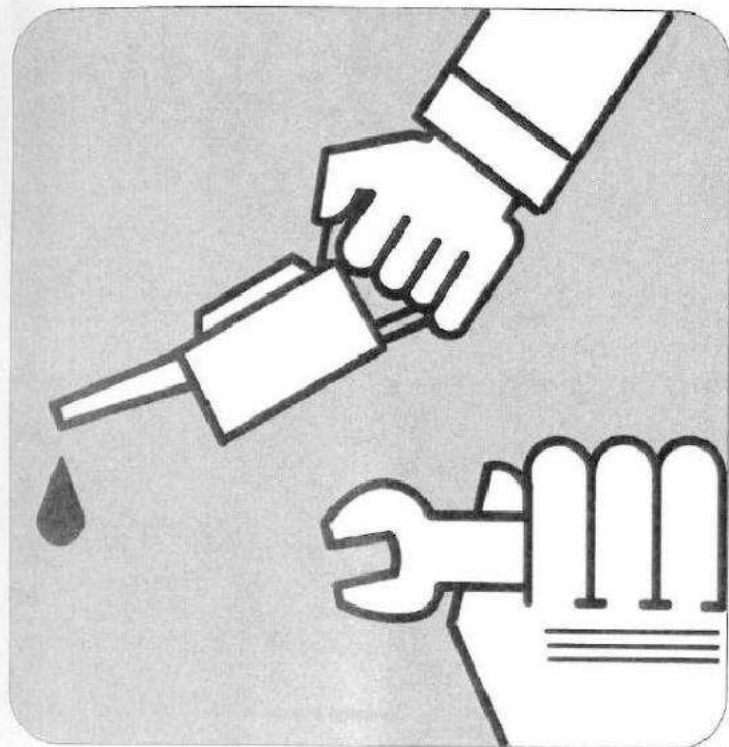

- General notes (46, 47)
- Tool kit, repair kit for tubeless tires (48)
- Removing/installing front wheel (49-51)
- Removing/installing rear wheel (51-54)
- Checking brake pads
  - Front wheel (55)
  - Rear wheel (56)
- Electrical system:
  - replacing bulbs,
  - adjusting headlight beam angle,
  - aiming headlight beam,
  - replacing fuses (57-60)
- Servicing battery (61, 62)
- Troubleshooting table (63)
- Cleaning/care (64, 65)
- Check, care and cleaning windshield (66)
- Storing motorcycle/restoring to service (67)

( ) Figures in brackets ⇒ Page on which item is described.

## Care and maintenance

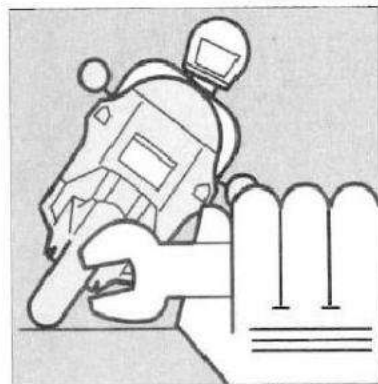

### General notes

The section which follows provides you with information regarding care and maintenance of your motorcycle. You will need certain technical knowledge and skill in using tools to perform the necessary care and maintenance jobs.

For further information, refer to the workshop manual or the circuit diagram file.

Only in this way can you be sure that the work which you perform will also bring you the desired success.

Your motorcycle reflects a high-technical standard. Special tools, special diagnostic and test systems as well as expert knowledge are required to keep your motorcycle in top shape.

Your BMW motorcycle dealer has the necessary technical expertise and properly trained staff. Take advantage of the help they can offer you. It will help ensure that your motorcycle is always in proper working order. Think of your own safety and trouble free operation of your motorcycle.

Do not attempt to perform more extensive work.

Have your motorcycle inspected and serviced at the specified intervals.

Use only Original BMW Parts and Accessories.

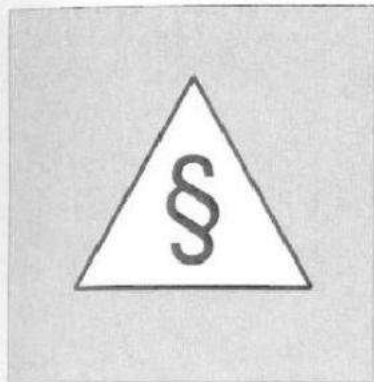

### Technical Modifications

Technical modifications are only permitted to a limited extent. Remember to comply with any legal requirements when modifying your motorcycle.

Your BMW motorcycle dealer will be glad to advise you on the merits of any modifications you have in mind, the legal situation and factory recommendations concerning specific technical modifications to your motorcycle.

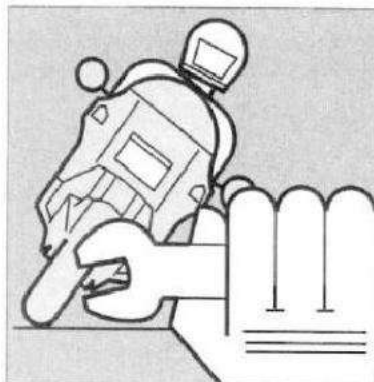

### Original BMW Parts and Accessories

For safety reasons use only Original BMW Parts and Accessories.

BMW is unable to inspect and test every after-market part and accessory and therefore cannot assume any responsibility for such non-BMW parts.

Original BMW Parts are identical to the parts originally used in your new BMW motorcycle.

Original BMW Parts, (components and accessory items supplied by BMW AG Motorcycle Division and BMW of North America, Inc.) are covered by limited warranties\* against defects in material and workmanship.

\* See your Warranty Information/Service History booklet for details on BMW Limited Warranties.

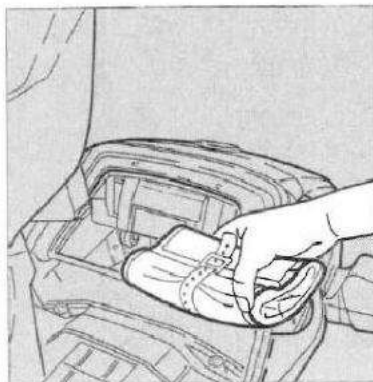

### Tool kit

- Toolkit in front right storage compartment in fairing.

#### Contents

- 1 leatherette case
- 1 multi-purpose pliers
- 1 large screwdriver (reversible blade)
- 1 small screwdriver
- 1 ABS feeler gauge
- 3 open-ended wrenches
  - 10 x 13 mm
  - 17 x 19 mm
  - 16 x 18 mm
- 2 ring wrenches
  - 10 x 12 mm
  - 17 x 19 mm

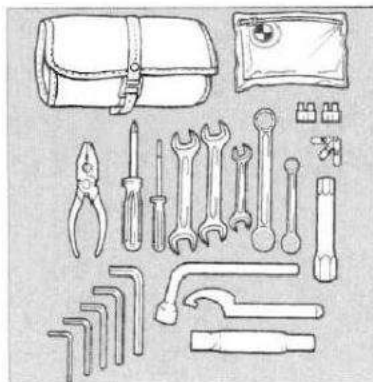

- 1 spark plug wrench
- 5 Allen keys
  - 3 mm,
  - 4 mm,
  - 5 mm,
  - 6 mm,
  - 8 mm.
- 1 box wrench for wheel studs
- 1 hook wrench for spring strut
- 1 tubular extension
- 1 flat fuses 15 A
- 1 flat fuses 7,5 A

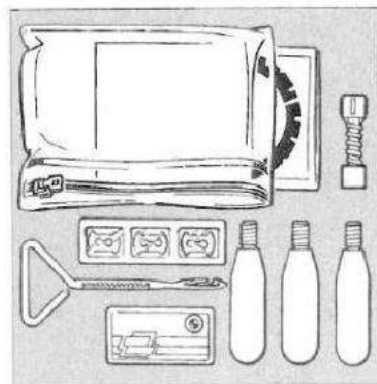

### Repair kit for tubeless tires

Only suitable for punctures up to 4 mm (0.61 in) in diameter.

Please refer to instructions with kit for repair procedure.

#### Warning

**Maximum speed:**

⇒ 60 km/h (37 mph) !

**Maximum distance:**

⇒ 400 km (250 miles)!

Always have tire renewed as soon as possible.



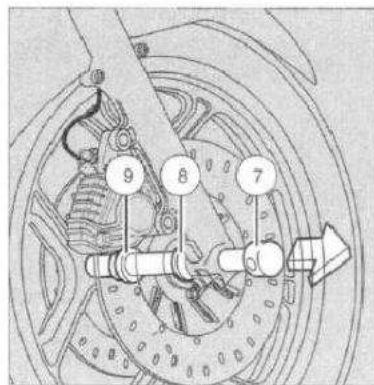
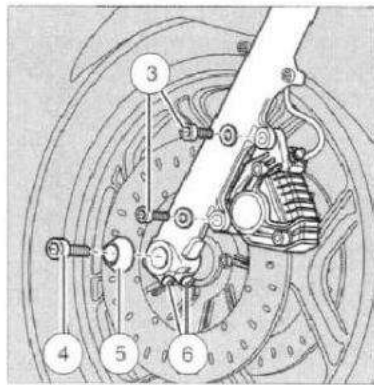
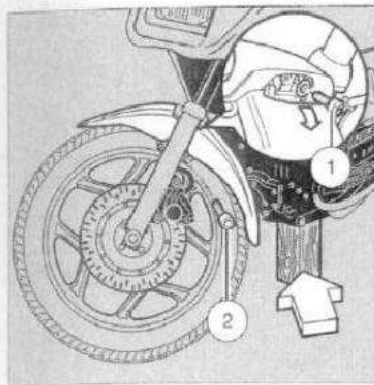

## Removing/installing front wheel

### Tools required

#### Allen keys

- 4 mm,
- 6 mm,
- 8 mm.

#### Open-ended wrench

- 13 mm.

#### Tubular extension

#### Caution

Do not damage brake discs and pads when removing.

Do not operate handbrake lever with wheel removed.

Keep wheel bearings free of dirt and moisture.

### Procedure for removing wheel

- Place motorcycle on center stand.
- Position support below engine (arrow), - front wheel exposed.
- Swing down the cover (arrow).
- Unscrew fastening bolts (1, 2).
- Take off fairing section.
- Mark installed position on tire or note direction of rotation arrow on tire.
- Unscrew fastening bolts (3) for left/right brake caliper.
- Unscrew axle bolt (4).
- Slacken axle clamp bolts (6).

- Withdraw stub axle (7).
- Take out left/right spacing bushings (8, 9).
- Take off brake calipers.
- Run front wheel out to the front.

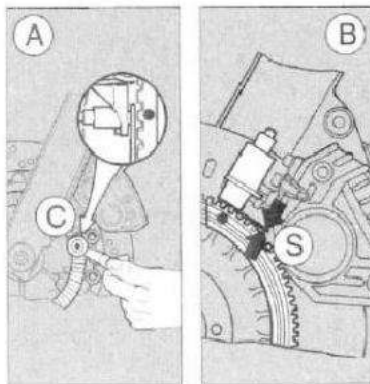
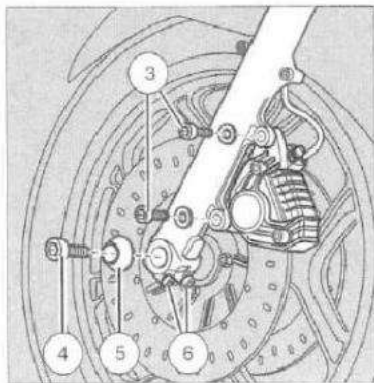
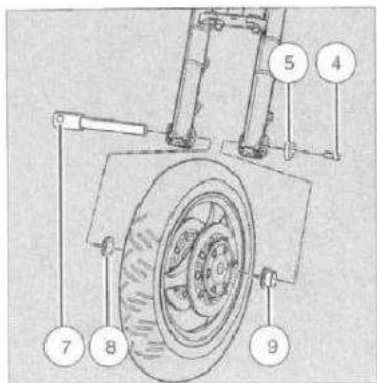

#### Procedure for installing wheel

- Roll front wheel in between forks. Pay attention to direction of rotation arrow or marking on tire.
- Fit left/right brake caliper onto brake discs.
- Insert spacing bushings.  
On left in direction of travel:  
**wide bushing (9);**  
On right in direction of travel:  
**narrow bushing (8).**
- Grease stub axle (7).
- Install stub axle from the right (raising wheel at same time).

- Fit on profile disc (5).
- Tighten axle bolt (4).
- Install brake calipers with mounting brackets and tighten bolts (3).
- Tighten left-hand axle clamp bolts (6).
- Remove support from below engine.
- Vigorously compress telescopic forks several times with handbrake applied.
- Tighten right-hand axle clamp bolts.

#### Check ABS sensor gap

##### Note

Extreme care must be taken when carrying out this work in order not to interfere with the correct functioning of the system.

##### Caution

After fitting wheel, it is essential to check the gap (S) at the point of the maximum distance (chisel punch "C"), and have it set by your BMW motorcycle dealer or a qualified service technician if necessary.

Gap (S) Front wheel	
with floating disc (A)	0,50 ... 0,55 mm
with fixed disc (B)	0,60 ... 0,65 mm

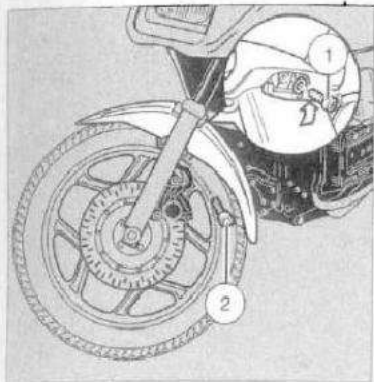

- Install fairing sections.
- Screw in fastening bolts (1, 2) with washers. Tighten gently.
- Close the cover (arrow) for retaining screw (1).

#### Tightening torques

- Axle bolt (6)  
⇒ 33 Nm (24 ft.lb.)
- Brake caliper bolt (4)  
⇒ 32 Nm (23 ft.lb.)
- Axle clamp bolts (8)  
⇒ 14 Nm (10 ft.lb.)

#### Caution

Do not damage brake discs and pads when installing.

Do not operate handbrake lever with wheel removed.

Have tightening torques checked by your BMW motorcycle dealer or a qualified service technician.

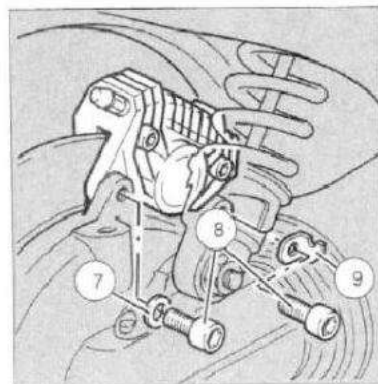
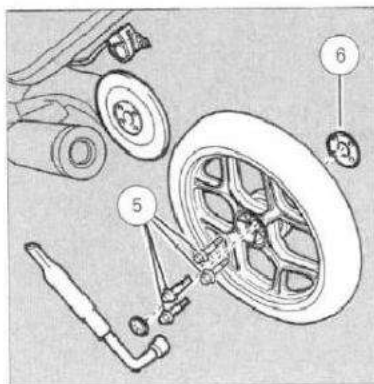
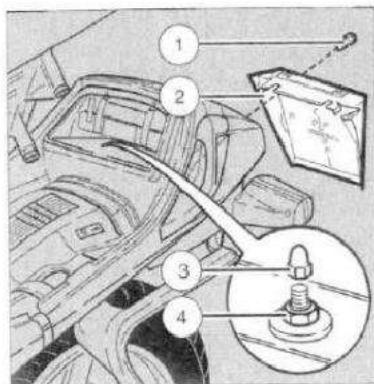

## Removing/installing rear wheel

### Tools required

Open ended wrench

– 10 mm.

Allen keys

– 8 mm.

Screwdriver with reversible blade.

Box wrench for wheel studs.

Tubular extension

### Caution

**Do not damage brake discs and pads when removing.**

**Do not operate brake pedal with wheel removed.**

### Procedure for removing wheel

- Place motorcycle on centre stand.
- Engage first gear.
- Take out the 2 Phillips-head screws (1) for the rear wheel cover (number plate holder) (2).
- Swing up the dualseat and remove the storage compartment cover.
- Pull off the 2 protective caps (3) at left and right, and **slacken off** the 2 hex nuts (4) but do not unscrew them fully.
- Pull the rear wheel cover off to the rear.

- Take out the 5 wheel studs (5) and take off the taper rings. (If necessary, take off the wheel stud cover first.)
- Detach the cable from the angled holder (9).
- Take out the 2 brake caliper screws (8).
- Lift the rear wheel away from its centering location.
  - Note spacer washer (6).
- Carefully remove the brake caliper from the brake disc.
- Roll the rear wheel out rearwards.

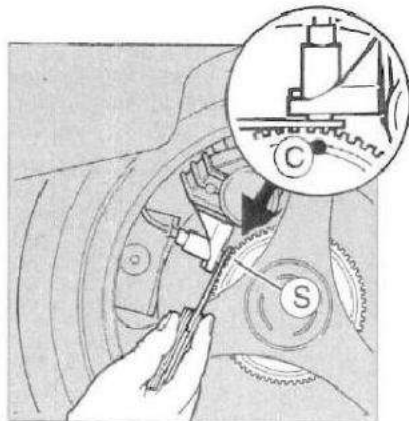
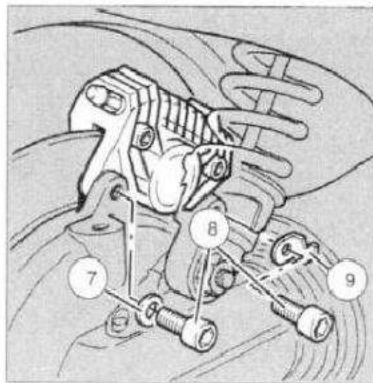
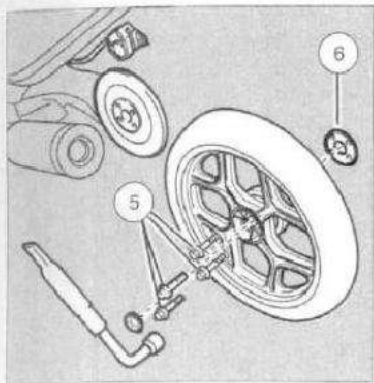

#### Procedure for installing wheel

- Check that the wheel centering location, wheel hub contact faces and spacing washers are free from grease.
- Push spacing washer (6) on to the wheel centering location.
- Carefully push the brake caliper on to the brake disc.
- Insert the rear wheel into the bore of the centering location.
- Screw in the wheel bolts (5) with tapered rings until hand-tight, then tighten them to the pre-load torque in a crosswise pattern.
- Tighten wheel bolts (5) to specified torque in a crosswise pattern. (If necessary, insert the wheel stud cover.)

- Insert the brake caliper screws (8) with their washers (7) and the angled holder (9) for the pulse transmitter cable.
- Attach the pulse transmitter cable to holder (9).

#### Check ABS sensor gap

##### Note

Extreme care must be taken when carrying out this work in order not to interfere with the correct functioning of the system.

##### Caution

After fitting wheel, it is essential to check the gap (S) at the point of the maximum distance (chisel punch point "C"), and have it set by your BMW motorcycle dealer or a qualified service technician if necessary.

##### Gap (S)

Rear wheel 0,60 ... 0,65 mm

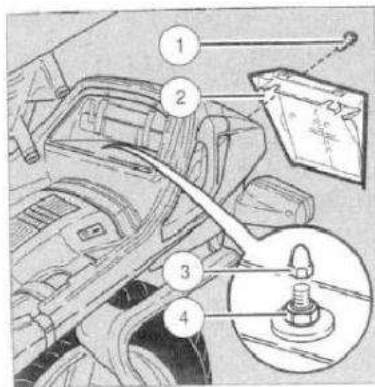

- Install the rear wheel cover (2).  
Note plastic washers.
- Tighten hex nuts (4) at left/right in storage compartment, and attach the protective caps (3).
- Close the storage compartment and swing down the dualseat.



#### Pre-load torque

- Wheel bolts (5)  
⇒ 50 Nm (36 ft.lb.)

#### Tightening torques

- Wheel bolts (5)  
⇒ 105 Nm (76 ft.lb.)

- Brake caliper bolts (9)  
⇒ 32 Nm (23 ft.lb.)

#### Caution

Do not damage brake discs and pads when installing.

Do not operate brake pedal with wheel removed.

Use only wheel and central bolts with the same length code number.

Have tightening torques checked by your BMW motorcycle dealer or a qualified service technician.

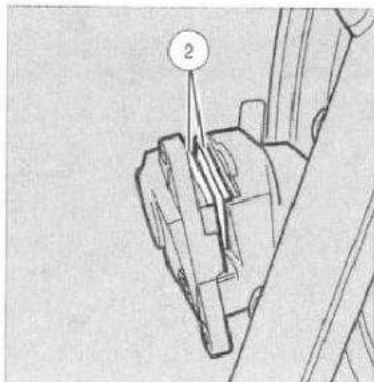
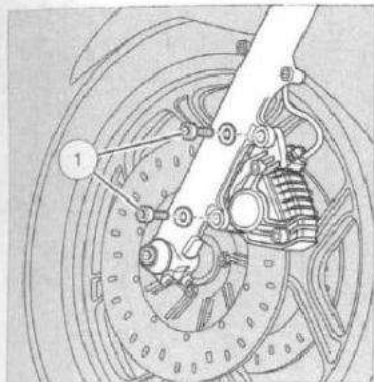

## Checking brake pads

### Front wheel

#### Tools required

##### Allen keys

- 4 mm,
- 8 mm.

##### Screwdriver with reversible blade.

#### Procedure

- Place motorcycle on center stand.
- Take off front wheel fairing (page 49).
- Remove fastening screws (1) for left/right brake calipers.
- Carefully remove brake calipers.

- Check/measure thickness of brake pads (2).

Minimum pad thickness:  
1.5 mm (0.06 in)

- Refit brake calipers in the reverse order.

#### Tightening torque

Brake caliper screws (1)  
⇒ 32 Nm (23 ft.lb.)

#### Note

Have work performed on brake system by your BMW motorcycle dealer or a qualified service technician.

#### Caution

Do not damage brake discs and pads when removing and installing brake calipers!

Do not operate handbrake lever with brake calipers removed!

Ensure brake pads have at least minimum thickness!

Have tightening torques checked by a qualified service technician!

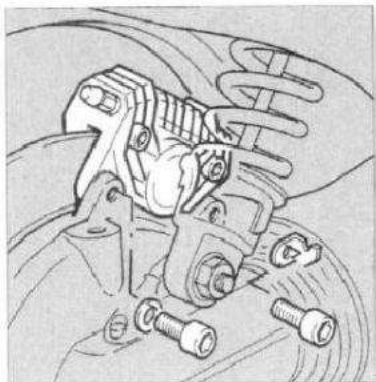

### Rear wheel

#### Tools required

Allen key  
– 8 mm.

#### Procedure

- Place motorcycle on center stand.
- Remove the rear wheel (see page 52).
- Remove the brake caliper (see page 52).
- Check thickness of brake pads (1).  
Minimum pad thickness:  
1.5 mm (0.06 in).
- Install in the reverse order.

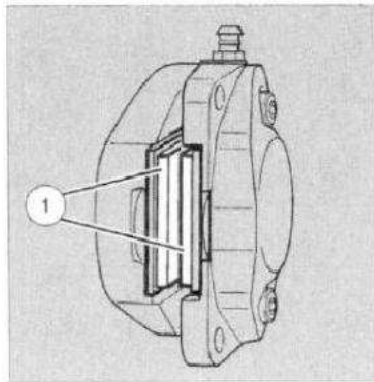

#### Tightening torque

Brake caliper screws (1)  
⇒ 32 Nm (23 ft.lb.)

#### Note

Have work performed on brake system by your BMW motorcycle dealer or a qualified service technician.

#### Caution

Do not damage brake discs and pads when removing and installing brake calipers!

Do not operate handbrake lever with brake calipers removed!

Ensure brake pads have at least minimum thickness!

Have tightening torques checked by a qualified service technician!

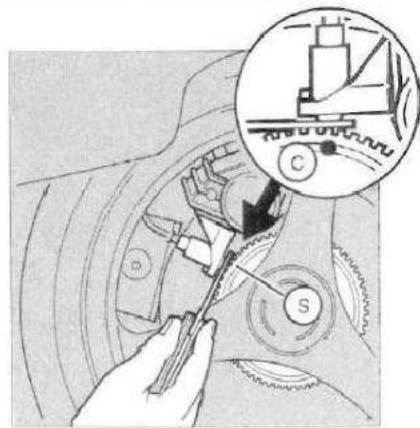

#### Check ABS sensor gap

#### Note

Extreme care must be taken when carrying out this work in order not to interfere with the correct functioning of the system.

#### Caution

After fitting brake caliper, it is essential to check the gap (S) at the point of the maximum distance (chisel punch point "C"), and have it set by your BMW motorcycle dealer or a qualified service technician if necessary.

#### Gap (S)

Rear wheel 0,60 ... 0,65 mm





## Electrical system

### Caution

Perform work on the electrical system only when ignition is switched off or battery negative cable disconnected!

Do not touch any live parts when engine is running or there may be a risk of a fatal accident!

### Note

Do not touch new bulbs with your bare fingers.

Use a clean, dry cloth to install.

If touching bulb cannot be avoided, remove finger prints before use.

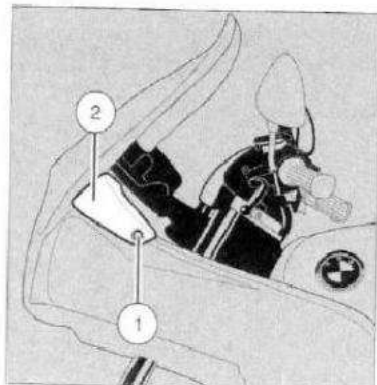

K 75 S

## Renewing front turn-signal bulb

### Tools required

Screwdriver with reversible blade

### Work sequence

- Place motorcycle on centre stand.
- Take out the retaining screw (1).
- Take off the flasher cover (2).
- Release the bulb holder by turning it to the left, and pull it out.
- Press the bulb in and turn it to the left to release it. Take the bulb out.
- Insert the new bulb into the holder, press in and turn to the right to secure.
- Insert the bulb holder in its catch again and secure by turning it to the right.
- Insert the flasher unit and screw it on firmly.

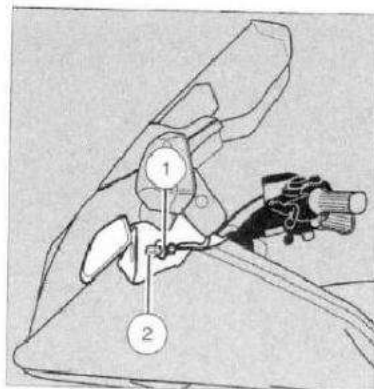

K 75 RT

## Renewing front turn-signal bulb

### Work sequence

Perform removal/installation work from the top. (Reach through between storage compartment, instrument cluster and handlebar.)

- Place motorcycle on centre stand.
- Turn handlebar to left or right.
- Release the bulb holder by turning it to the left, and pull it out.
- Press the bulb (2) in and turn it to the left to release it. Take the bulb out.
- Insert the new bulb (2) into the holder, press in and turn to the right to secure.
- Insert the bulb holder in its catch again and secure by turning it to the right.

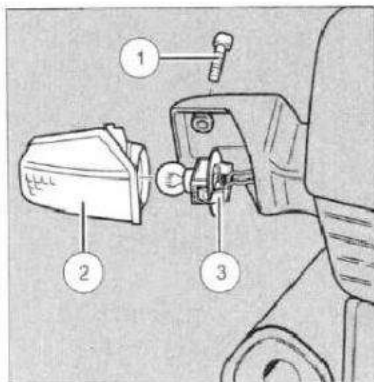

### Renewing flasher bulb, front left/right

#### Tools required

Screwdriver with reversible blade

#### Work sequence

- Place motorcycle on centre stand.
- Take out retaining screw (1).
- Take out flasher cover (2).
- Press plastic catch (3) to release bulb holder, and remove it.
- Press bulb in and turn to left to release. Take the bulb out.
- Insert new bulb into catch and turn to right to secure.
- Install in the reverse order of work.
- Front/rear indicator bulbs: ⇒ 12V 21W

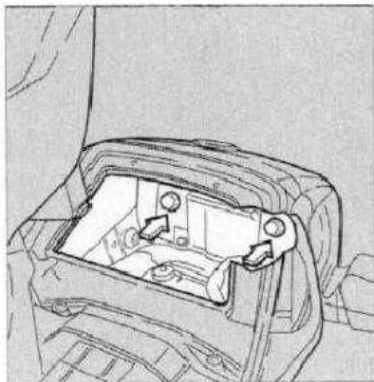

### Renewing rear light bulb and brake light bulb

#### No tools required.

#### Procedure for removing bulb

- Place motorcycle on center stand.
- Open the dualseat. Remove the cover from the storage compartment.
  - The rear light insert is behind the ABS control unit.
- Reach through under the ABS control unit and take out the two knurled screws (arrow).
- Detach the rear light assembly.
 

Light assembly:

Top ⇒ brake light

Bottom ⇒ rear light

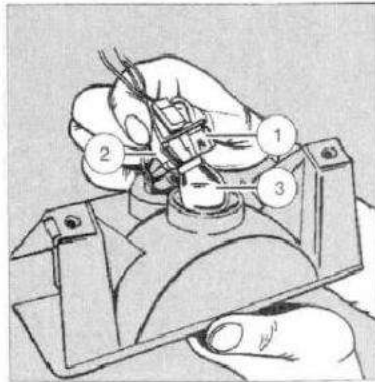

- Remove the bulb insert (1) by pressing in plastic catch (2).
- Press the brake/rear light bulb (3) to the rear (arrow) and release it from its holder by turning it to the left (arrow). Take out the bulb.
- Install in the reverse order of work.
  - Brake light: ⇒ 12V 21W
  - Rear light: ⇒ 12V 10W

#### Note

Do not touch new bulbs with your bare fingers.

Use a clean, dry cloth for installing.

If touching bulb cannot be avoided, remove finger prints before use.

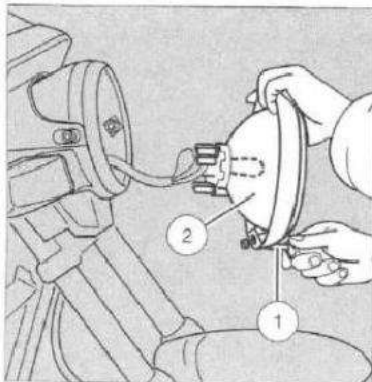

K 75

### Renewing low/high beam headlight bulb or parking light bulb

#### Tools required

Screwdriver with reversible blade

#### Work sequence

Removal/installation work is carried out from the front.

- Place the motorcycle on its centre stand.
- Take out the Phillips-head screw (1).
- Take off the headlight insert (2).
- Renew the low/high beam headlight bulb or the parking light bulb.
- Install bulb in the reverse order.

– Headlight bulb ⇒ 60/55W

– Parking light bulb ⇒ 12V 4W

#### Note

Do not touch new bulbs with your bare fingers. Use a clean, dry cloth for installing. If touching bulb cannot be avoided, remove finger prints before use.

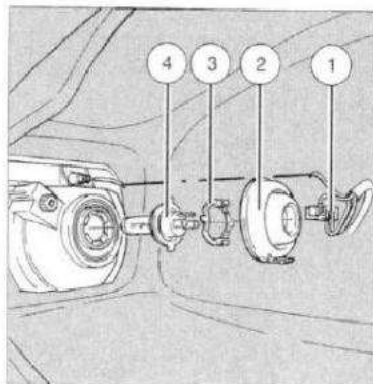

K 75 S, K 75 RT

### Renewing headlight bulb

#### No tools required

#### Procedure for removing bulb

Remove/install bulb through bottom fairing opening.

- Place motorcycle on center stand.
- Take off multiple connector (1).
- Remove rubber seal (2).
- Release locking ring (3) by turning to the left. Remove bulb (4).
- Install bulb in the reverse order.
- Headlight bulb ⇒ 60/55W

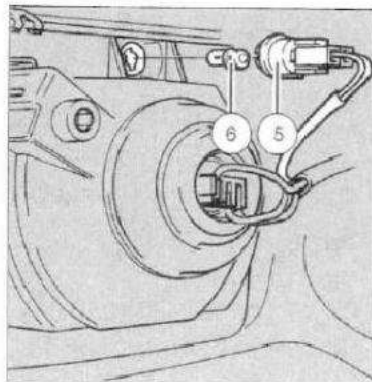

K 75 S, K 75 RT

### Renewing parking light bulb

#### No tools required

#### Procedure

- Place motorcycle on center stand.
- Release bulb holder (5) by turning to the left.
- Release bulb (6) by pressing in and turning to the left at the same time.
- Install bulb in the reverse order.
- Parking light bulb ⇒ 12V 4W

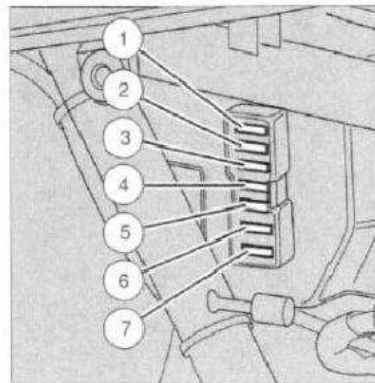
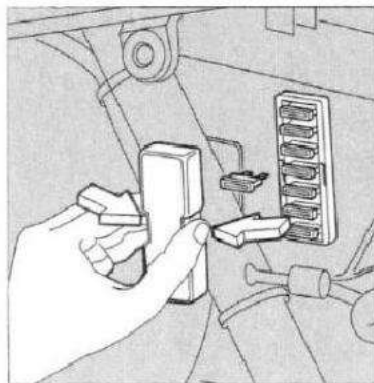
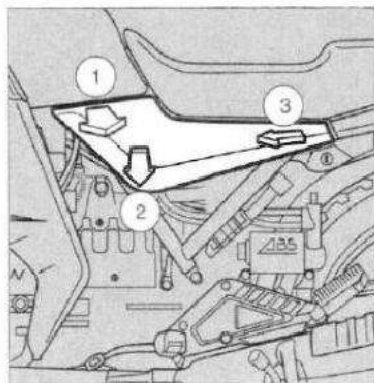

## Renewing fuses

No tools required.

### Procedure

- Place motorcycle on centre stand.
- Take off the battery cover as shown in the drawing.

- Compress transparent cover slightly at the sides (arrows) and withdraw.
- Pull blown fuse out of holder.
- Insert new fuse (spare fuses in tool kit).
- Install parts in the reverse order.

### Note

Do not repair blown fuses.

If fuse blows frequently, have electrical system checked by your BMW motorcycle dealer or qualified Service technician.

## Electrical circuits and fuses

Fuse assignment:

1	Instrument cluster, rear/brake lights	7,5 A.
2	Parking light	7,5 A.
3	Indicator lights, clock	15 A.
4	Power socket	15 A.
5	Special equipment option	15 A.
6	Fuel pump	7,5 A.
7	Two-tone horns, fan	15 A.

### Caution

Use only specified fuse types and ratings.

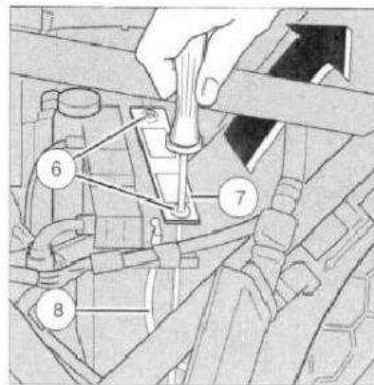
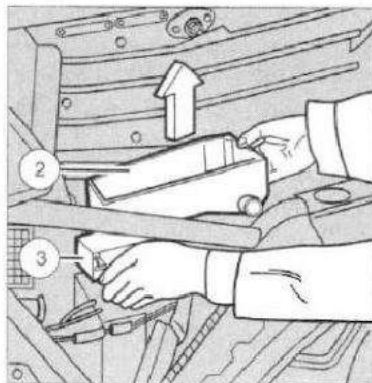
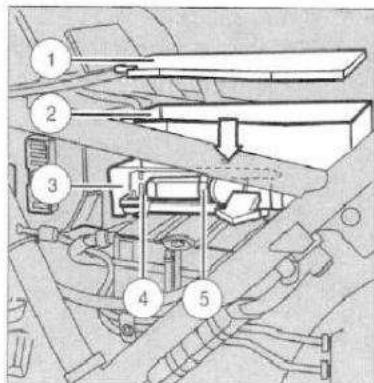

## Removing and installing battery

### Tools required

Allen keys

- 4 mm

Open ended wrench

- 10mm

Screwdriver with reversible blade.

### Procedure for removing battery

- Place motorcycle on center stand.
- **Switch off ignition!**
- Open the dualseat.
- Remove the left-hand battery cover.
- Open the storage tray (2) and take off the cover (1).
- Insert a screwdriver blade through the hole (arrow) in the base of the tray, press it forwards (arrow) and release the catch (4) on the multi-pin plug (5) for the fuel injection control unit (3).

- Pull off the multi-pin plug carefully, release it from the catch and press it to one side.
- Take the storage tray (2) out of the frame together with the fuel injection control unit (3).
- Take out the two Phillips-head screws (6) and remove the battery retaining hoop (7).
- Disconnect battery cables.  
⇒ **first of all from negative terminal.**  
⇒ **then from positive terminal.**
- Pull battery vent tube (8) out of hole in rear wheel cover.
- Lift out battery to the rear/up the way (arrow).

### Caution

**It is essential to disconnect negative/positive cables in the correct order!**  
**Disconnect battery terminals only when ignition switched off!**

### Procedure for installing battery

- Install bulb in the reverse order.
- Connect battery terminal cables.  
⇒ **first positive terminal.**  
⇒ **then negative terminal.**
- Grease terminal posts.

### Note

**Do not overtighten the battery holder screws (5).**

### Caution

**Do not kink vent tube (8)!**

**It is essential to connect positive/negative terminal cables in the correct order!**

**Connect battery terminal cables only when ignition switched off!**

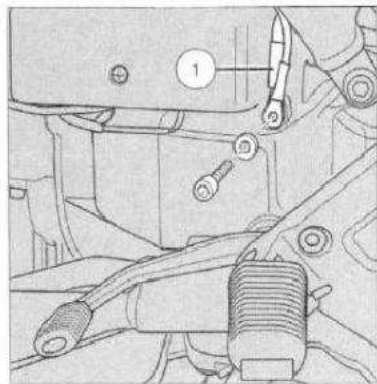
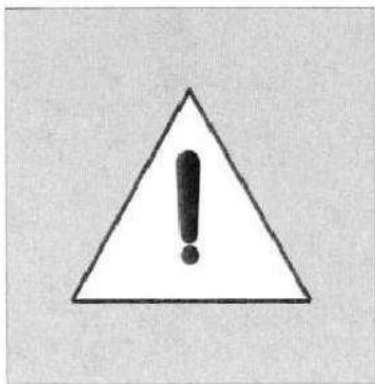
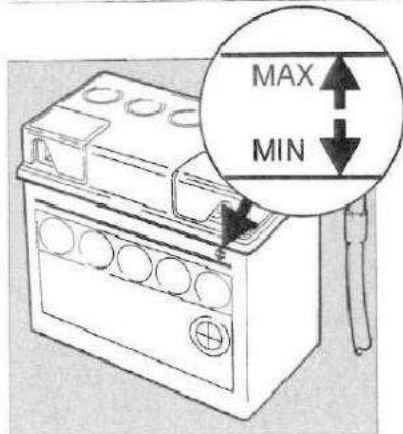

## Checking electrolyte level

### Procedure

- Read off electrolyte level at MIN/MAX markings.

### Note

Use only distilled water for topping up battery.

Remove filler plugs and screw in with a coin.

### Caution

Battery acid is corrosive to metal or enamel surfaces.

Before recharging or removing a battery, always switch off engine and disconnect the terminals.

Never run the engine without the battery connected, or else the alternator may be destroyed.

Check that battery venting hose is routed correctly, and open.

### Warning:

The battery contains sulfuric acid. Avoid contact with skin, eyes or clothing. Antidote: EXTERNAL-Flush with water, INTERNAL-Drink large quantities of water or milk.

Follow with milk of magnesia, beaten egg or vegetable oil.

Call physician immediately.

Eyes: Flush with water and get prompt medical attention.

Batteries produce explosive gases. Keep sparks, flames and cigarettes away. Always shield eyes when working near batteries.

**KEEP OUT OF REACH OF CHILDREN!**

Recharge battery only in a well ventilated area.

Filler caps must be tight.

## Maintenance instructions

- If the motorcycle is not ridden for more than a month, disconnect battery terminals.

### Procedure:

Unscrew the negative cable (1) at the gear box and insulate it.

- Top up distilled water to MAX mark.
- Store battery in a cool and dry place.
- Check electrolyte level regularly.
- Suggestion: Connect the BMW motorcycle battery charger for 1 day every 4 weeks to maintain optimum battery life.

### Caution

Always follow instructions for maintaining, charging and storing the battery. This not only battery life, it is also essential for recognition of warranty claims.

## Troubleshooting table

### Caution

A dangerous or even fatal accident could be caused by touching any live component while the engine is running.

Malfunction	Possible cause	Remedial action	Page
Engine will not start or is difficult to start	Ignition key not in correct position	Refer to operating instructions	41
	Ignition kill switch not turned on	Refer to operating instructions	41
	Power supply interrupted	Fuse 5 blown	60
	Gear engaged, clutch lever not pulled up	Select neutral or disengage clutch	43
	Fuel tank empty	Refuel	28
	Fuel pump not working	Fuse 6 blown	60
	Throttle twistgrip/choke not operating properly	Refer to operating instructions	42
	Air filter element blocked	Renew	
	Spark plug(s) faulty/damp	Renew	
	Spark plug leads/caps damp	Dry with compressed air jet	
Coolant temperature too high, warning light remains on all the time (comes on above 115 °C)	Battery insufficiently charged	Charge battery	62
	Coolant too low	Trace and repair any leaks; add coolant	29
	Electric fan not switching on automatically (at 105 °C)	Fuse 7 blown	60

### Note

Any more serious faults, and other faults not described on pages 45...68, should be entrusted to a BMW motorcycle dealer or qualified service technician for attention.

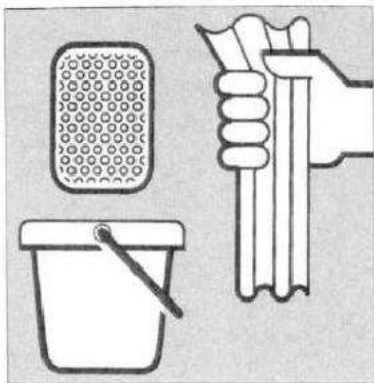

## Cleaning/Care

Most motorcycle owners are familiar with the way an admiring crowd of all ages gathers round a sparkling clean motorcycle whenever it is parked for a few minutes.

Who would not be just a little proud to receive this public recognition of his efforts.

Of course, there are many successful methods of cleaning. Most motorcyclists have devised their own ways of tackling the job.

In view of the problems that can occur even with modern cleaning products and equipment, and the very real risk of damaging the motorcycle or spoiling its appearance, we have compiled a few hints which may be useful.

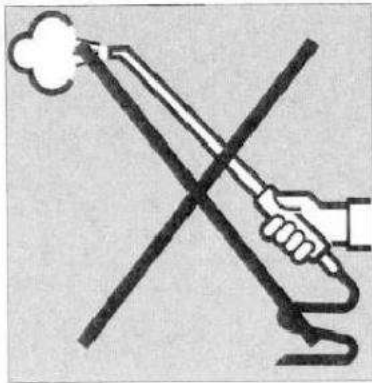

## Caution

We do not recommend high-pressure water or steam cleaners, because the powerful pressure may damage normal seals at the wheels, etc., may uplift paint damaged by stones and may also penetrate the breather covers at the gearbox and final drive and electrical or electronic equipment and fittings and the hydraulic brake system. The consequences can often be expensive to repair, and may actually cause a safety hazard.

- A better approach: spray very dirty areas, e.g. wheels and transmission, with an approved mild-action engine or cold cleaner, allow this to soak in for the period of time specified by the supplier and then wash it off with a mild spraying water jet. Place the motorcycle on the side stand so that the motorcycle is tilted to the left to drain water from the top of the engine. Finally, dry thoroughly.

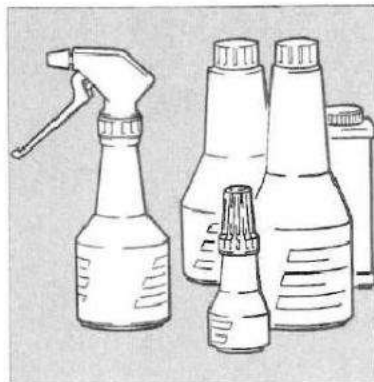

- After washing the motorcycle down in this way, it is advisable to test the brakes.
- Rubber and plastic components, particularly flashing turn indicators, rear light, instrument cluster, switches, etc., must be protected against cleansers and solvents.
- Wash paintwork with a mild, non alkaline dishwashing liquid and plenty of clean water, using a clean sponge or wash-leather. Remove dead insects in the same way.
- Clean/care for fairing sections only with approved BMW cleaning/care products. Do not scratch windscreen.
- Remove tar stains only with approved removers. Rinse down thoroughly afterwards.
- Treat chrome parts and paintwork regularly with suitable approved BMW care products.



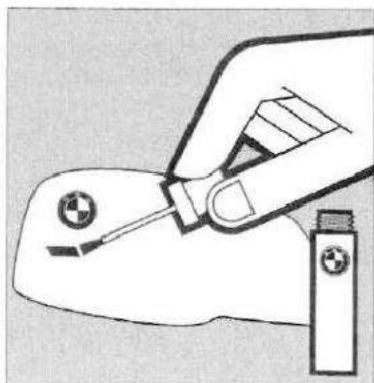
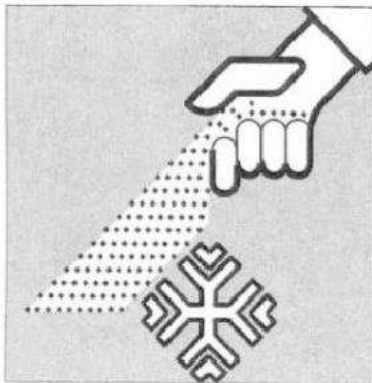

#### Removing road salt

- Clean motorcycle at the end of your ride immediately with cold water.
  - ⇒ **Do not use warm water as this increases the chemical action of the salt!**
- Dry motorcycle thoroughly.
- Use a commercial wax-based corrosion proofing agent to treat rims, engine, swing arms and chrome parts.
- Rub/polish cleaned and dried fairing sections with an approved wax product.

#### Caution

**Do not use steam cleaners or high pressure jets!**

#### Touching up paint damage

- Touch up minor paint damage caused by flying stones or similar with BMW Touch Up Stick.
  - ⇒ **Paint color indicated on decal below dualseat.**
  - ⇒ **Pay attention to manufacturer's instructions for use.**
- Have major damage to paintwork attended to by your BMW motorcycle dealer.
- Only through proper care will your motorcycle finish be maintained. Avoid prolonged exposure to sunlight or your paint finish may fade or be damaged eventually. Cover your motorcycle when not in use.

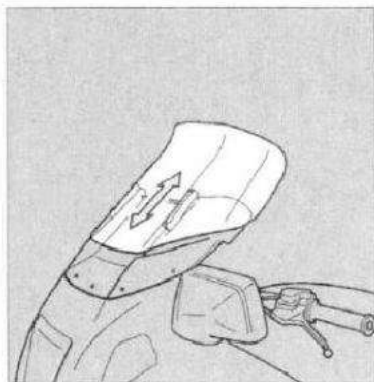

K 75 RT

### check the windshield

#### Warning:

Check mounting hardware periodically. A loose mount places undue stress on the windshield and could possibly result in premature failure.

Never ride your motorcycle with loose or missing windshield mounting hardware. Check the hardware tightness regularly.

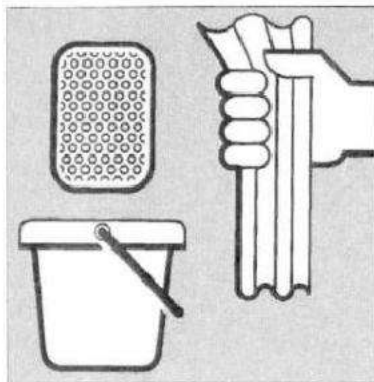

### Care and cleaning windshield

Your windshield is made of prime G.E. Lexan<sup>®</sup> FMR hardcoated polycarbonate sheet. Always pre-rinse screen with water to remove grit and soften dirt. Wash with mild liquid soap, lots of warm water, and a clean soft cloth or sponge. Rinse well to remove all soap residue. Dry with a chamois, flannel or moist sponge to prevent water spots. Paint, grease; Use a cotton ball moistened with turpentine, follow with wash as described above. This also works on label residue.

If a hairline scratch or abrasion occurs on your windshield it can be minimized with a non-silicone polish. The polish will make cleaning easier and fill scratches, making them invisible. Recommended products:

- Meguiar's Mirror Glaze Professional Plastic Cleaner #17 BMW P/N 88 88 2 000 003
- Meguiar's Mirror Glaze Professional Plastic Polish #17 BMW P/N 88 88 2 000 004



### Caution

Do not clean Lexan<sup>®</sup> hardcoated polycarbonate in hot sun or high temperature. Powered, abrasive, or alkaline cleaners will damage the windshield. Never scrape the windshield with a razor blade or other sharp instrument as permanent damage will result.

Your BMW windshield is constructed from surface-hardcoated polycarbonate sheet which may not be compatible with certain cleaning or rain-shedding products, particularly (but not limited to) those of acidic origin. These products can penetrate the hardcoating, particularly around the edges and areas of stress (sharply formed bends) creating foggy or glare spots. Damage resulting from these products is not covered under the BMW Limited Warranties.

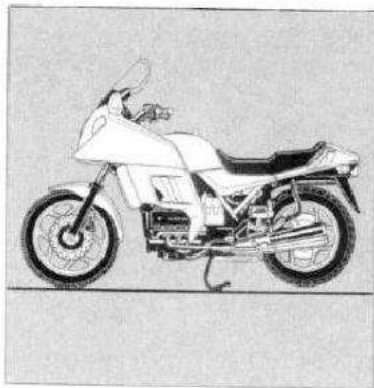
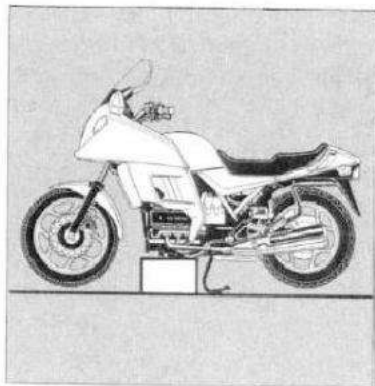

## Storing motorcycle

### Procedure

- Clean motorcycle (see page 64).
- Remove battery (see page 61). Pay attention to maintenance instructions (see page 62)!
- Lubricate brake pedal and clutch lever joints, center and side stand bearings.
- Spray bright metal/chrome parts S 100 Corrosion Protectant.
- Store motorcycle in a dry room on center stand.
- Place block under the engine so that both wheels are off the ground.

### Note

**Before the motorcycle is laid up out of use, ask your BMW motorcycle dealer to change the engine oil and renew the oil filter element.**

**Work needed in connection with laying up the motorcycle or restoring it to the road is best combined with an Inspection or Oil Service performed by the BMW motorcycle dealer.**

## Restoring motorcycle to use

### Procedure

- Remove protective coatings applied to exterior.
- Clean motorcycle (see page 64).
- Install fully-charged battery (see page 61).
- Treat battery terminal posts and clips with protective grease.
- Check/correct tire inflation pressure (see page 33).
- Check brakes (see pages 30-32).
- Perform safety checks (see pages 25-36).



# Specifications

**And just as important:**

## **Technical data and descriptions**

- Engine (70)
- Power transmission (71)
- Frame (72, 73)
- Fuels, lubricants etc. (74, 75)
- Electrical systems (76)
- Dimensions (77)
- Weights (78)

( ) Figure in brackets ⇒ Page on which item is described.

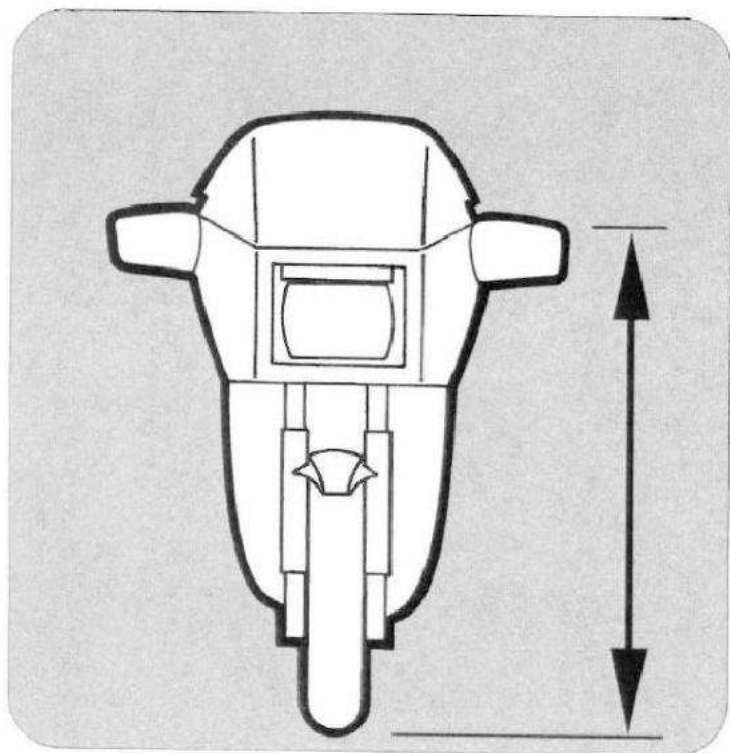

## Technical data and descriptions

Engine		K 75	K 75 S	K 75 RT
Type		Patented, longitudinal inline flat-three, compact four-stroke engine with two overhead camshafts, water cooling, electronic fuel injection, overrun fuel shutoff and a microprocessor-controlled digital ignition system.		
Displacement	ccm	740		
Max. permissible engine speed	rpm	8700		
Max. continuous engine speed	rpm	8600		
Idle speed	rpm	950 +/- 50		
Bore/stroke	mm	67/70		
Compression ratio		11.0:1		
Type of fuel		Unleaded middle or premium grade fuel, minimum octane number 89 (Anti Knock Index $(R+M)/2$ ) or minimum octane number 95 (RM) and 85 (MM).		

Transmission		K 75	K 75 S	K 75 RT
<b>Clutch</b>		Single dry plate, mounted on output shaft and revolving in opposite direction to crankshaft, with lever-action disc spring, aluminium forged flywheel and asbestos-free clutch linings; responsive mechanical release action with low release forces, clutch lever force approx. 70 N.		
Clutch plate $\varnothing$	mm (in)	165	(6.5)	
<b>Gear box</b>		Constant-mesh 5-speed gearbox with integral shock-absorber and weight-reducing aluminium components.		
Gear ratios		1st = 4.50		
		2nd = 2.96		
		3rd = 2.30		
		4th = 1.88		
		5th = 1.67		
<b>Power transmission from gearbox to rear wheel</b>		New type of propeller shaft with torsional vibration damper housed in swinging arm (BMW "monolever"); arm pivot aligned with universal joint axis to avoid changes in shaft length. At both ends, drive through flank-centred involute splines.		
<b>Rear wheel drive</b>		Crown wheel and bevel pinion with pallid gear pattern running in antifriction bearings, with rear wheel attached directly to flange formed on back of crown wheel. Integral castellated ring and inductive transmitter supply ratio-independent pulses to electronic speedometer.		
Final drive ratio (Standard version)		3,20 : 1		
Number of teeth		32/10		

<b>Frame and suspension</b>		<b>K 75</b>	<b>K 75 S</b>	<b>K 75 RT</b>
<b>Frame</b>		Single-section torsionally rigid lattice tube frame enclosing engine and gear box assembly as stressed element; not approved for sidecar or trailer attachment.		
Location of Vehicle Identification Number (V.I.N.)		On rear right frame tube strut.		
<b>Suspension</b>				
Front		Long-stroke responsive telescopic fork with travel dependent hydraulic dampers and progressive spring rates.		
Total spring travel	mm (in)	135	(5.31)	
Stanchion diameter	mm (in)	41.4	(1.63)	
Rear		Swinging arm (BMW "monolever") made from a high-strength light alloy, with a single suspension strut (progressive-rate coil spring and double-acting gas-filled telescopic damper); three-position setting to suit varying loads.		
Total spring travel (at wheel)	mm (in)	114	(4.49)	
Swing arm length	mm (in)	400	(15.7)	
<b>Max lock angle of front wheel</b>		2 x 40°	2 x 35°	2 x 34°
<b>Front wheel caster</b>				
At unladen weight	mm (in)	101	(3.98)	
In normal-load position with 75 kg (165 lbs) rider	mm (in)	105	(4.13)	
<b>Front wheel brake</b>		Hydraulic, twin disc, with slotted stainless-steel brake discs and two fixed calipers with semi-metallic brake pads.		
<b>Rear wheel brake</b>		Part-integrated hydraulic disc brake.		



<b>Frame and suspension</b>			<b>K 75</b>	<b>K 75 S</b>	<b>K 75 RT</b>
<b>Wheels and tires</b>			BMW cast light alloy wheels of Y-spoke design, and H-profile pattern		
<b>Front wheel</b>			with inclined shoulder rim and double hump		
	Size and designation		2.50 x 18 MT H2		
	Tire size and designation		100/90 - 18 56V TUBELESS		
<b>Rear wheel</b>			with inclined shoulder rim and double hump		
	Size and designation		2.75 x 17 MT H2		
	Tire size and designation		130/90 - 17 68V TUBELESS		
<b>Tire pressures</b> with cold tires					
One-up	front	bar (p.s.i.)	2.2	(31.9)	
	rear	bar (p.s.i.)	2.5	(36.3)	
Two-up	front	bar (p.s.i.)	2.5	(36.3)	
	rear	bar (p.s.i.)	2.9	(42.0)	
<b>Tire tread depth</b> (minimum recommendation)					
	Front wheel	mm (in)	2	(0.079)	
	Rear wheel	mm (in)	3	(0.118)	
<b>Note legal requirements concerning minimum tread depth.</b>					

## Oils and lubricants

K 75

K 75 S

K 75 RT

## Engine oil

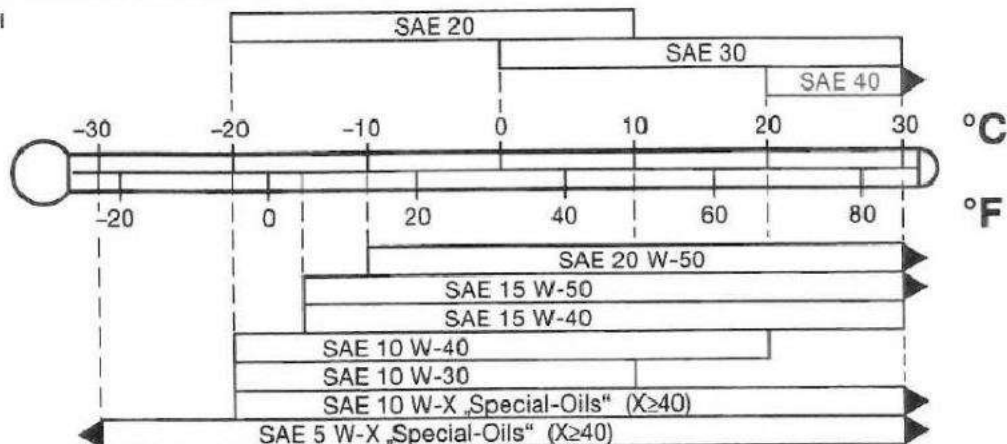

Brand HD oil for with API classification SF, SG or SH; extensions CD and CE are permitted; or brand HD oil with CCMC classification G4 or G5; extension PD2 is permitted.

Viscosity class depending on outside temperature.

The temperature limits of SAE classes can be exceeded or undercut for short periods.

The "special oils" are approved in name by BMW AG and available from your BMW motorcycle dealer. All engine oils sold by BMW are subjected to permanent BMW quality control.

Oil additives of all kinds are rejected by the manufacturer.

## Engine oil content

without filter renewal	l	3.50
if filter is renewed	l	3.75

<b>Oils and lubricants</b>		<b>K 75</b>	<b>K 75 S</b>	<b>K 75 RT</b>
<b>Gear oil</b>		Proprietary Hypoid gear oil, API Class GL 5		
Gearbox capacity	l (fl.oz.)	0.8	(27.00)	
Rear wheel drive capacity	l (fl.oz.)	0.25	(8.45)	
<b>Viscosity class at outside temperature</b>				
above 5 °C	SAE	90		
below 5 °C	SAE	80		
Alternatively	SAE	80 W 90		
<b>Telescopic fork oil – approved grades</b>		Esso Comfort		
Content per fork leg				
Refilling after dismantling	cc (fl.oz.)	420	(14.00)	
After oil change	cc (fl.oz.)	410	(13.67)	
<b>Steering bearing lubrication and other lubrication points</b>		Proprietary anti-friction grease, useful temperature range 30 °C...+140 °C, pour point 150 °C...230 °C, high corrosion protection, good water/oxidation resistance; e.g. Shell Retinax A.		
<b>Battery terminal posts – oxidation protection</b>		Acid-free grease, e.g. Vaseline		
<b>Brake fluid</b>		BMW DOT 4, ATE "SL" DOT 4, Castrol Disc Brake, DOW ET 504 Shell Donax DOT 4, Hydraulan DOT 4		
<b>Engine coolant</b>		BMW Anti-Freeze/coolant or proprietary longlife antifreeze and corrosion inhibitor.		
		<b>Caution</b>		
		<b>Use only antifreeze and corrosion inhibitors free of nitrite!</b>		
Capacity	l (qts.)	3 + 0,4 (3.17 + 0.42) (in expansion tank)		

<b>Electrical system</b>		<b>K 75</b>	<b>K 75 S</b>	<b>K 75 RT</b>
<b>Battery</b>		12V BMW-Mareg, with transparent polypropylene casing		
Voltage/capacity	V/Ah	12/25 (standard version)		
<b>Ignition timing (full load)</b>		°CS		
		6...31 (advance)		
<b>Spark plugs</b>		M 12 x 1.25 thread		
Approved makes and types		Bosch XR 5 DC, Beru 12R-5 DU		
Electrode gap	mm (in)	0.6 + 0.1 (0.024 + 0.004)		
Maximum Electrode Gap	mm (in)	0.9 (0.035)		
<b>Circuit protection</b>		"Minifuse" (flatpin) fuses, 7 circuits		
Load rating	A	7,5	(3 circuits)	
	A	15	(4 circuits)	
<b>Headlight</b>		180Ø	170 x 110	200 x 130
<b>Bulb</b>		H4 Halogen 12V 60/55W, asymmetric dipped beam		
Headlight high/dipped beam		H4 Halogen 12V 60/55W, asymmetric dipped beam		
Parking light	DIN 72601	12V 4W, standard designation T/4		
Rear light: Tail light	DIN 72601	12V 10WE, standard designation R 19/10		
Brake light	DIN 72601	12V 21W, standard designation P 25-1		
Turn signal lights	DIN 72601	12V 21W (4x), standard designation P 25-1		
Turn signal telltale lights	DIN 72601	12V 4W (2x), standard designation T 8/4		
Other telltale lights and instrument lighting	DIN 72601	12V 3W (13x), standard designation W 10/3		

<b>Dimensions</b>		<b>K 75</b>		<b>K 75 S</b>		<b>K 75 RT</b>	
Overall length	mm (in)	2220	(87.40)			2230	(87.80)
Width over mirrors	mm (in)	900	(35.43)	810	(31.89)	916	(36.06)
Width over handlebars (with weights)	mm (in)	710	(27.95)	650	(25.59)	770	(30.31)
Width over rider's footrests	mm (in)	620	(24.40)				
Width over pillion footrests	mm (in)	675	(26.57)				
Max. height (excl. mirrors)	mm (in)	1300	(51.18)	1340	(52.76)	1460	(57.48)
Seat height at unladen weight	mm (in)	760/800	(29.92/31.49)	810	(31.89)	810	(31.89)
Wheel base							
At unladen weight	mm (in)	1516	59.69				
In normal-load position with 75 kg (165 lbs) rider	mm (in)	1511	(59.49)				
Ground clearance							
At unladen weight	mm (in)	175	(6.89)				
In normal-load position	mm (in)	150	(5.91)				
Turning circle	m (ft)	5,1	(16.72)	5,4	(17.70)	5,1	(16.72)

<b>Weights</b>		<b>K 75</b>		<b>K 75 S</b>		<b>K 75 RT</b>	
Dry weight (without fuel, coolant, lubricant, tools)	kg (lbs)	204	(450)	211	(465)	234	(515)
Unladen weight (ready for road, with full tank)	kg (lbs)	228	(502)	235	(518)	258	(564)
Gross weight limit	kg (lbs)	480	(1057)				
<b>Wheel load limits</b>							
Front	kg (lbs)	200	(441)				
Rear	kg (lbs)	315	(694)				
<b>Axle load distribution front/rear</b>							

# Alphabetical Index

**A...Z**

**Adding fuel, 28****Alternator, Warning light, 40****Antilock Braking System (ABS)**

## Acting and operating

Cancel switch, 22

General Operation, 22

Important notes, 23

Check sensor gap, front, 50

Check sensor gap, rear, 53, 56

Notes on operating, 21

What ABS Means on the Road, 20

Axle load distribution, 78

**Battery**

Checking electrolyte level, 62

Maintenance instructions, 62

Removing/installing, 61-68

Voltage/capacity, 76

Before starting the engine, 41

**BMW**

Cleaning/care products, 64

Parts and Accessories, 47

Bore/stroke, 70

**Brake**

Checking brake pads

Front wheel, 55

Rear wheel, 56

Fluid, 75

Fluid level

front/rear, 30

Topping up, 31

Handbrake lever travel, 32

Pedal travel, 32

Test before starting, 30

Breaking-in rules, 39

**Bulbs**

Headlight, 59

Parking light, 59

Technical data, 76

Turn-signal, 57, 58

**Care and maintenance, 46**

Checking brake pads, 55-56

Check ABS sensor gap, 56

**Cleaning/Care, 64-68**

Exhaust system, 65

Removing road salt, 65

Touching up paint damage, 65

Correcting coolant level, 29-36

**Electrical system**

Adjusting headlight beam angle, 36

Checking electrolyte level, 62-68

For countries with leftside rule of the road, 36

Removing/installing battery, 61-68

**Renewing bulbs**

Headlight, 59

Parking light, 59

Turn-signal, front, 57

Turn-signal, rear, 58

Renewing fuses, 60

General notes, 46

**Original BMW**

Parts and Accessories, 47

Removing/installing front wheel, 49-52

Check ABS sensor gap, 50

Tightening torques, 51

Removing/installing rear wheel, 52-54

Check ABS sensor gap, 53

Tightening torques, 54

Repair kit for tubeless tires, 48

Restoring motorcycle, 67

Storing motorcycle, 67

Technical Modifications, 47

Tool kit, 48

Topping up brake fluid, 31-36

Troubleshooting table, 63-68

Catalytic converter, 38

Center stand, 44

Changing gears, 43

**Choke**

Operating, 42

Resetting, 42

Circuit protection, Load rating, 76

**Cleaning/Care, 64-68**

High-pressure water cleaner, 64, 67

**Clutch, 71**

Lever travel, 32

Plate XX, 71

Compression ratio, 70

Continuous engine speed, 70

**Coolant**

Capacity, 75

Correcting level, 29

Level, 29

Mixing ratio, 29

Coolant temperature gauge, 40

**Dimensions, 77**

Displacement, 70

Dry weight, 78

Dualseat lock, 19

**Electrical system****Battery**

Checking electrolyte level, 62

Maintenance instructions, 62

Removing/installing, 61-68

Fuses, Renewing, 60

**Headlight beam**

Adjusting, 36

Aiming, 36

**Renewing bulbs**

Headlight, 59

Parking light, 59

Turn-signal, 58

**Technical data, 76**

Battery, 76

Blubs, 76

Circuit protection, 76

Headlight, 76

Ignition timing, 76

Spark plugs, 76

Electrode gap, 76

Electrolyte level, 62

**Engine**

Coolant, 75

Capacity, 75

Oil pressure, 27



- Speed limits, 39
- Starting, 41
- Technical data, 70
  - Bore/stroke, 70
  - Compression ratio, 70
  - Displacement, 70
  - Engine speed, 70
  - Idle speed, 70
  - Type, 70
  - Type of fuel, 70
- Engine oil, Level, 27
- Exhaust system, 65
- Final drive ratio, 71
- Frame and suspension, 72
- Front wheel, Size and designation, 73
- Front wheel caster, 72
- Fuel
  - Adding, 28
  - Gauge, 14, 28
  - Level, 13, 28
  - Type of, 28, 70
- Fuses, 76
  - Renewing, 60
- Gear display, 41
- Gearbox, 71
  - Gear ratios, 71
  - Oil capacity, 75
  - Power transmission, 71
- Gears, Changing
  - Shifting down, 43
  - Shifting up, 43
- Gross weight, 78
- Ground clearance, 77
- Handlebar controls, 15
- Hazard warning flashers, 16
- Headlight, Bulb, 59, 76
- Headlight beam
  - Adjusting, 36
  - Leftside rule of the road, 36
- Heated handlebar grips, 16
- Height, max., 77
- High performance ignition system, 26
- High-pressure water cleaner, 64, 67
- Horn control, 15
- Idle speed, 70
- Ignition
  - Kill switch, 15
  - /steering lock, 12
  - Switching on, 41
- Ignition timing, 76
- Important Safety Information, 4
- Instrument unit, 13
- Keys, 12
- LCD Digital clock, 17
- Length, overall, 77
- Lights, 35
- Loads, 35
  - Axel, 78
  - Wheels, 78
- Lock angle, front wheel, 72
- Odometer, 13
- Oil
  - Approved grades, 74
  - Capacity
    - Engine, 74
    - Gearbox, 75
    - Rear wheel drive, 75
    - Telescopic fork, 75
  - Checking, Engine, 27
  - Pressure, 27
  - Viscosities, 74
- Operating choke, 42
- Operating instructions
  - Adding fuel, 28
  - Antilock Braking System (ABS)
    - Notes on operating, 21
    - What ABS Means on the Road, 20
  - Dualseat lock, 19
  - Fuel gauge, 14
  - Handlebar controls, 15
  - Hazard warning flashers, 16
  - Heated handlebar grips, 16
- Ignition and steering lock, 12
- Instrument unit, 13
- Keys to motorcycle, 12
- LCD Digital clock, 12
- Temperature gauge, 14
- Turn-signals (self cancelling), 15
- Original BMW Parts and Accessories, 47
- Paint damage, 65
- Parking light bulb, 59, 76
- Permissible engine speed, 70
- Permissible gross weight, 35
- Power sockets, 17
- Power transmission, 71
- Radio, 18
- Reading lamp, 18
- Rear light, Telltale, 40
- Rear light bulb, 76
- Rear wheel, Size and designation, 73
- Rear wheel drive, 71
  - Final drive ratio, 71
  - Number of teeth, 71
  - Oil capacity, 75
- Repair kit (tires), 48
- Reporting Safety Defects, Inside front cover
- Restoring motorcycle, 67
- Rims, Safety check, 33
- Road salt, 65
- Safety checks
  - Brake fluid level, 30
  - Brake pedal travel, 32
  - Clutch lever travel, 32
  - Coolant level, 29
  - Engine oil level, 27
  - Fuel level, 28
  - General note, 26
  - Handbrake lever travel, 32
  - High performance ignition system, 26
  - Lights, 35
  - Loads, 35
  - Rims/wave caps, 33
  - Side stand, 34

- Spring strut preload, 34
- Tire pressures, 33
- Tread depth, 33
- Safety information, 4
- Seat height, 77
- Selecting neutral, 41
- Side cases, Maximum speed, 35
- Side stand, 34, 44
- Spark plugs
  - Approved makes and types, 76
  - Electrode gap, 76
- Speedometer, 13
- Spring strut preload, 34
- Spring travel, front/rear, 72
- Stanchion diameter, 72
- Starter switch, 42
- Starting the engine, 41
- Starting-Riding-Parking
  - Before starting the engine, 41
  - Breaking-in rules, 39
  - Catalytic converter, 38
  - Changing gears, 43
  - Charge current/Alternator, 40
  - Coolant temperature gauge, 40
  - Engine oil pressure, 27
  - Engine speed limits, 39
  - Operating choke, 42
  - Placing motorcycle
    - Center stand, 44
    - Side stand, 44
  - Pressing starter switch, 42
  - Rear light telltale, 40
  - Resetting choke, 42
  - Selecting neutral, 41
  - Switching on ignition, 41
- Storage compartments, 19
- Storing motorcycle, 67
- Stroke, 70
- Swing arm length, 72
- Switch
  - Horn control, 15
  - Ignition kill, 15
  - Starter, 15, 42
- Turn-signal, 15
- Turn-signal cancel, 15
- Switching on Ignition, 41
- Technical data and description**
  - Dimensions, 77
  - Engine, 70-78
  - Frame and suspension
    - Caster, front wheel, 72
    - Lock angle, front wheel, 72
    - Spring travel, front/rear, 72
    - Stanchion diameter, 72
    - Swing arm length, 72
    - Vehicle Identification Number, 72
    - Wheels and tires, 73
  - Oil and lubricants, 74
  - Transmission
    - Clutch, 71
    - Gearbox, 71
    - Rear wheel drive, 71
  - Weights, 78
  - Technical Modifications, 47
  - Telescopic fork, Oil capacity, 75
  - Telltale
    - ABS, 13, 40
    - High beam, 13
    - Neutral/gearbox, 13, 41
    - Rear light monitor, 13, 35, 40
    - Turn-signal, 13
  - Telltale lights bulb, 76
  - Temperature gauge, 14
  - Tightening torques
    - Brake caliper screw, 55, 56
    - Front wheel, 51
    - Rear wheel, 54
  - Tilt angle, 77
  - Tire
    - Pressure, 33, 73
    - Repair kit, 48
    - Size and designation, 73
    - Tread depth, 33, 73
  - Tool kit, 48
  - Transmission
    - Clutch, 71
  - Gearbox, 71
  - Rear wheel drive, 71
  - Tread depth, 33
  - Trip odometer, 13
  - Troubleshooting table, 63
  - Turn-signal, Bulb, 76
  - Turn-signal
    - Bulb, 57
    - Cancel switch, 15
    - Self cancelling, 15
    - Switch, 15
    - Telltale, 13
  - Turning circle, 77
  - Unladen weight, 78**
  - Valve caps, 33
  - Vehicle Identification Number, 72
  - Warning light**
    - ABS, 13, 22
    - Alternator, 13, 40
    - Coolant temperature, 13, 29
    - Engine oil pressure, 13, 27
    - Fuel level, 13
  - Weights, 78
  - Wheel**
    - Caster, front, 72
    - Load limits, 78
    - Lock angle, front, 72
    - Removing/installing, front, 49
    - Removing/installing, rear, 52
    - Safety check, 33
    - Size and designation, 73
  - Wheel base, 77
  - Width**
    - over handlebars, 77
    - over mirrors, 77
    - over pillion footrests, 77
    - over rider's footrests, 77
  - Windshield**
    - Care and cleaning, 66
    - checking, 66
    - Windshield adjusting, 18



BMW 16 63 01 47 9 799 027 Own.hanbook 4

**BMW AG Motorcycle Division**

Bestell-Nr. 01 47 9 799 027 09.95 3. Auflage engl.US