

Rider's Manual

US Models

K100 RS

K100 RT

K100 LT

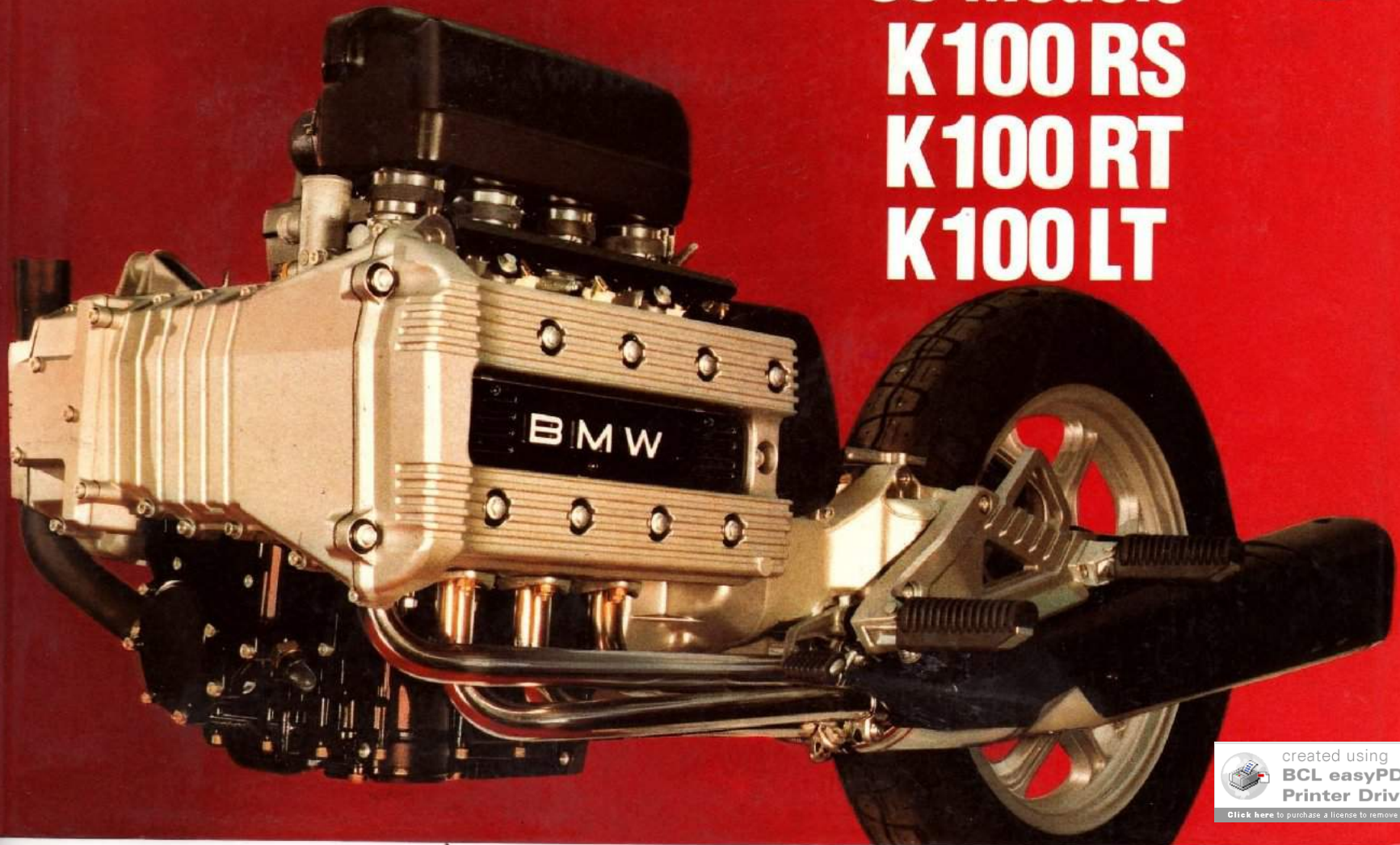

"MAINTENANCE, REPLACEMENT, OR REPAIR OF THE EMISSION CONTROL DEVICES AND SYSTEMS MAY BE PERFORMED BY A QUALIFIED SERVICE TECHNICIAN OR INDIVIDUAL, USING CERTIFIED MOTORCYCLE PARTS".

YOUR BMW IS COVERED BY THE FOLLOWING WARRANTIES:

- Limited Warranty
- Noise Emissions Warranty
- Emissions-Related Defect Warranty
- Emission Warranty (Models bought and registered in California)

DETAILED INFORMATION ABOUT THESE WARRANTIES IS LISTED IN BMW'S CONSUMER WARRANTY INFORMATION BOOKLET

Please Note: Important Safety Information

For your personal safety, BMW recommends that you use only parts and accessories approved by BMW.

By using Original BMW Parts and Accessories tested and approved by BMW, you can enjoy the assurance of knowing that these products have been certified after the appropriate testing as suitable for using on, or in conjunction with, your BMW motorcycle. BMW assumes full responsibility for these products when used as directed.

BMW assumes no liability whatsoever for parts and accessories which it has not approved.

When you use such non-approved products on your BMW motorcycle you do so at your own peril. BMW is unable to determine for every after-market part and accessory whether each can be used without creating a risk of injury or death to you and/or your passenger.

Original BMW Parts, BMW Accessories and other products approved by BMW, together with competent advice on all matters concerning them, can be obtained from any authorized BMW dealer.

Rider's Manual

US Models

K 100 RS

K 100 RT

K 100 LT

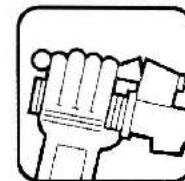

Operating instructions

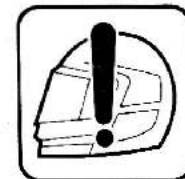

Safety hints

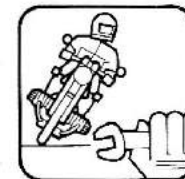

Riding hints, minor repairs

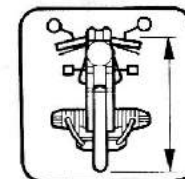

Specifications and technical descriptions



Care and maintenance



Alphabetical Item Index

BMW Motorrad GmbH + Co.

Bestell-Nr. 01 47 9 798 447 1.2 188 4. Aufl. engl. US Bo

created using
BCL easyPDF
Printer Driver

[Click here to purchase a license to remove this image](#)

Important Notice

Your BMW motorcycle conforms to all applicable U.S. Federal Motor Vehicle Safety Standards and U.S. Environmental Protection Agency Regulations effective on the date of manufacture.

This motorcycle has been designed for use in a prudent and reasonable manner by a qualified operator. It is intended for on-road use as a vehicle only. Operation in forest, bush or grass covered areas may be illegal. Obey local laws and regulations.

Whether you are a novice or an experienced rider, **become familiar with this Rider's Manual before you ride the motorcycle.**

Pay special attention to passages which are preceded by the following expressions:

Warning

– marks the possibility of **danger** for the operator or another person, unless instructions are followed.

Caution

– marks the possibility of **damage** to the motorcycle or parts thereof, unless instructions are followed.

Note

– marks recommendations which are useful or vital for proper **use or maintenance** of your motorcycle.

It is recommended that maintenance be performed by an authorized BMW dealer using genuine BMW parts.

Maintenance, replacement or repair of the emission control devices or systems may be performed, at your expense, by any motorcycle repair establishment or individual using any motorcycle part which is certified under those regulations without voiding the warranty.

In the interests of continuing technical development, we reserve the right to modify designs, equipment and accessories.

Dimensions, weights and performance data are listed at generally accepted tolerances. Errors and omissions excepted.

© 1988 BMW Motorrad GmbH + Co.

Not to be reproduced wholly or in part
without the written permission of BMW
Motorrad GmbH + Co., Technical Service
Department.

Printed in the Federal Republic of Germany.

Dear motorcyclist and BMW enthusiast,

BMW has always pursued a consistent and far-sighted design policy.

The famous BMW flat-twin motorcycle was basically conceived sixty years ago, and has been developed and refined since that time so that its current versions are as attractive as ever. Now, to join that splendid range of machines, BMW has created new and revolutionary models for the discerning rider:

The new BMW 'K' range of motorcycles.

Ultra-modern technologies have been incorporated into a brilliant step forward in motorcycle design that is quite without parallel. The "BMW Compact Drive System" has been patented worldwide, and blends efficiently and neatly with such reliable, well-proven mechanical elements as the BMW shaft drive.

We congratulate you on choosing this advanced, high-quality motorcycle.

For your own personal safety and protection of your new motorcycle, we urge you to read this manual carefully before operating the machine. The advice it contains will enhance your riding pleasure and insure your safety and make it easier for you to operate, handle and look after this high-performance motorcycle.

In conclusion, may we wish you and those who ride with you many an enjoyable journey.

Yours sincerely,

BMW Motorrad GmbH + Co.

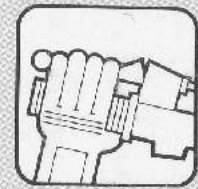

Operating
Instructions



Safety hints

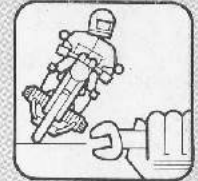

Riding hints,
minor repairs

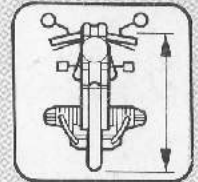

Specifications and
technical descriptions



Care and
maintenance



Care and
maintenance

created using
**BCL easyPDF
Printer Driver**

[Click here to purchase a license to remove this image](#)

2

Have the
facts at
your
fingertips!

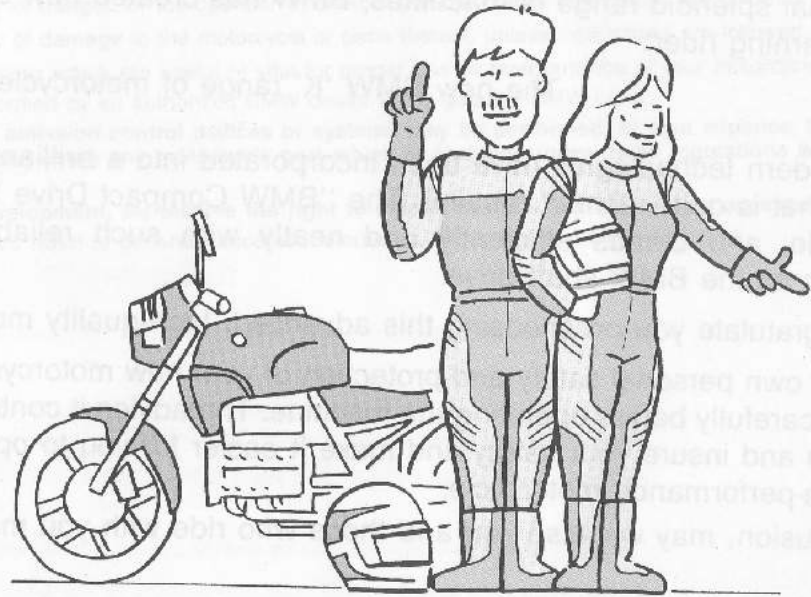

"M
AN
DI
YO
-
-
-
DE
SU

Pic
For
BM
By
ass
for
pro
BM
Wh
is u
cre
Orig
adv

Before you start – what you need to know – Operating instructions

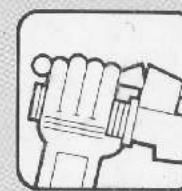

Operating instructions

Prevention is better than . . . – Safety hints



Safety hints

Aim for perfection – and enjoy troublefree riding – Riding hints, minor repairs

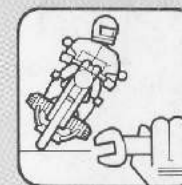

Riding hints, minor repairs

Data and information – Specifications

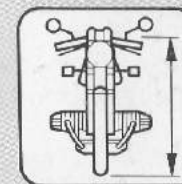

Specifications and technical descriptions

For reliable results – Care and maintenance – Genuine BMW Parts and Accessories



Care and maintenance

Alphabetical Item Index



created using
**BCL easyPDF
Printer Driver**
[Click here to purchase a license to remove this image](#)

Before you start – what you need to know!

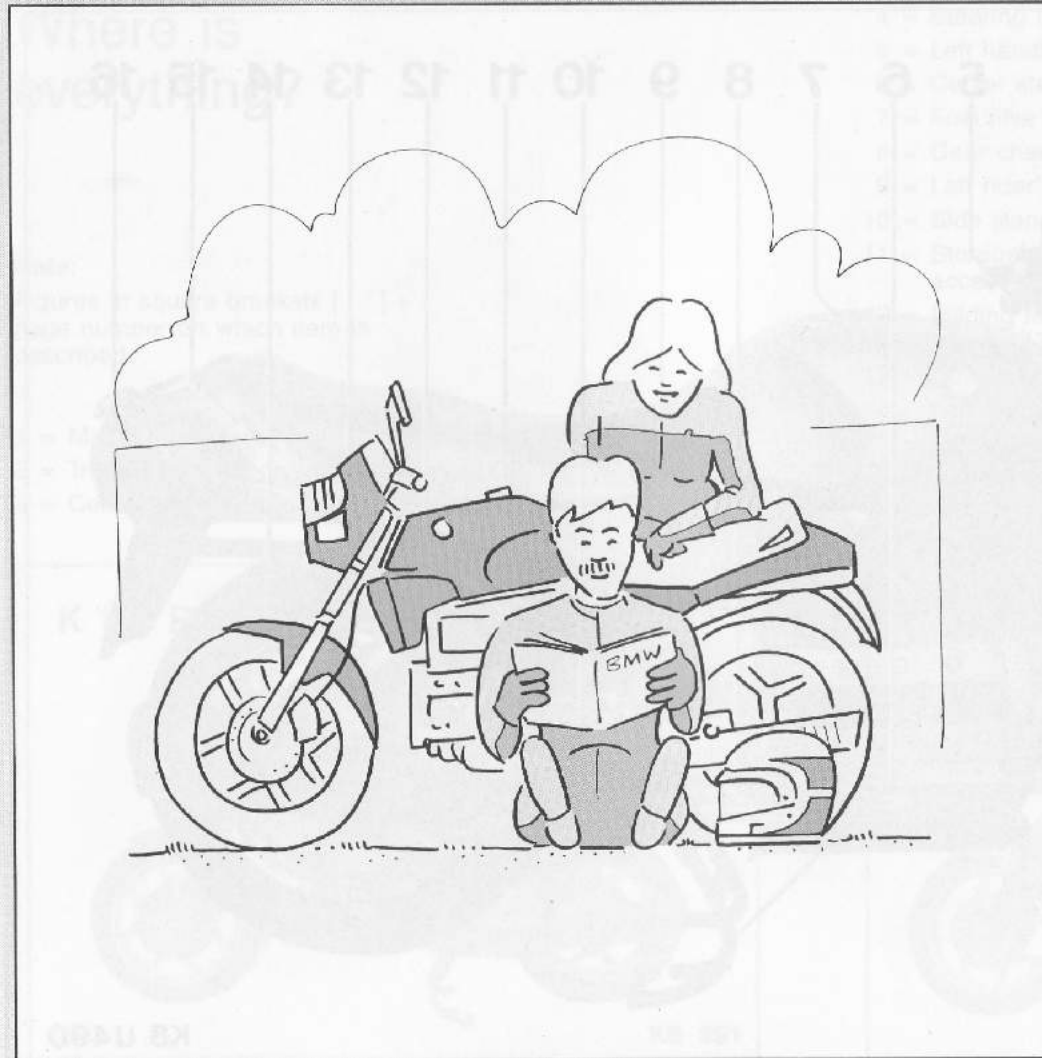

Where is everything?

- General views of motorcycle

How does it work?

- Ignition switch
- Central instrument unit
- Trip distance recorder
- Handlebar controls
- Fuel filler lock
- Dualseat lock
- Storage space
- LCD digital clock
- Spoiler adjustment

Safety checks before you start

- Engine oil level
- Coolant level
- Fuel level
- Brake fluid level
- Checking handbrake and foot brake
- Checking clutch lever
- Spring strut ('monoshock') setting
- 'Nivomat'
- Checking tire pressures
- Checking lights

On the road:

Starting – riding – parking

- Ignition cut-out switch
- Starting a cold or warm engine
- Rear light monitor
- Gear change
- Center and side stands
- Steering lock
- Helmet holder
- Burglar alarm



K 100 RS

- 1
- 2
- 3
- 4
- 5
- 6
- 7
- 8
- 9
- 10
- 11
- 12
- 13
- 14
- 15
- 16

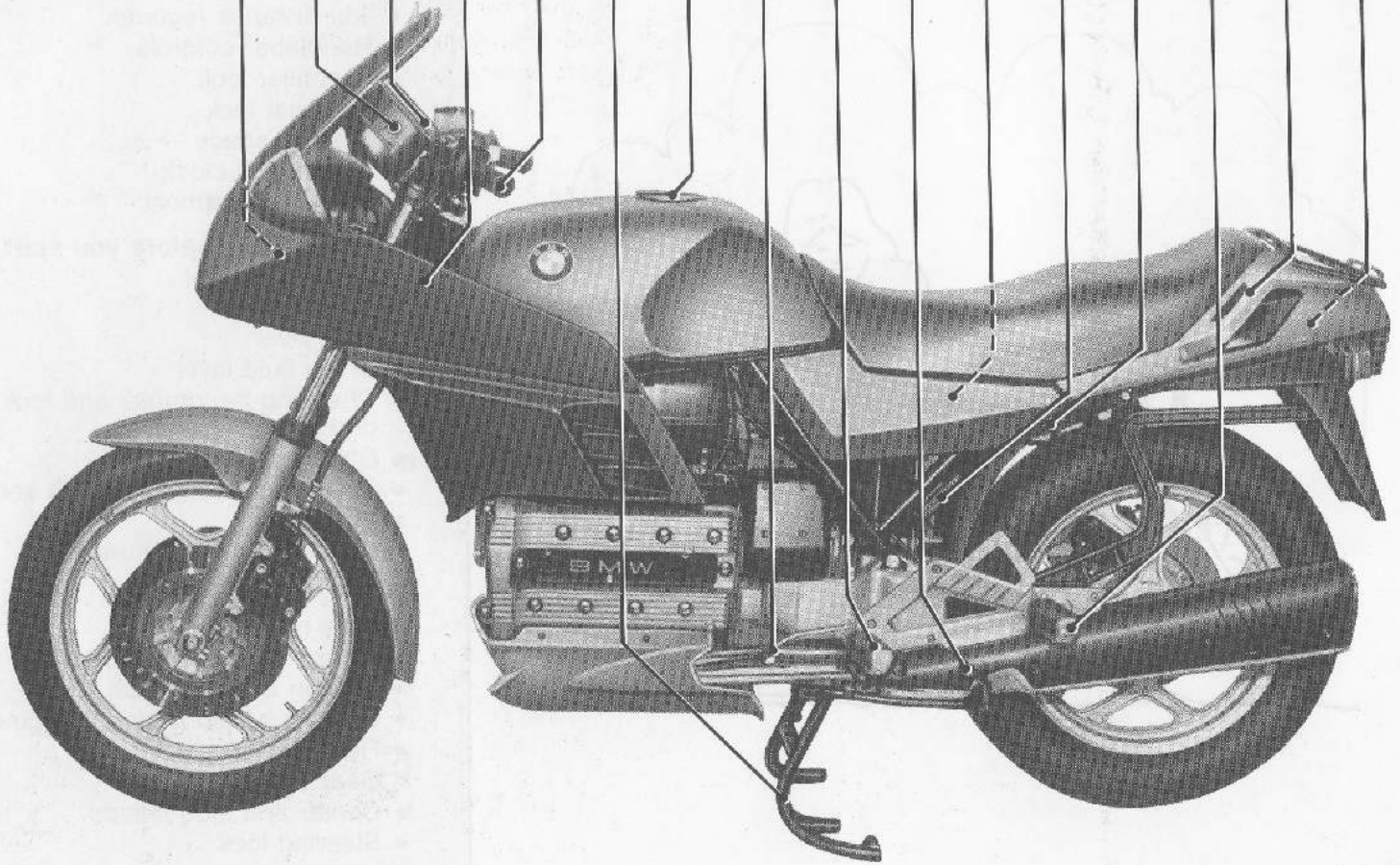

Where is everything?

Note:

Figures in square brackets [] = page number on which item is described

- 1 = Manual headlight beam throw adjuster [43]
- 2 = Trip distance recorder reset knob [13]
- 3 = Central instrument cluster [12, 13, 16, 18, 22]

- 4 = Steering lock [25]
- 5 = Left handlebar fitting [14]
- 6 = Center stand [24]
- 7 = Fuel filler lock [14]
- 8 = Gear change pedal [23]
- 9 = Left rider's footrest
- 10 = Side stand [24]
- 11 = Storage tray for first aid kit (optional extra), accessible when dualseat is open [15]
- 12 = Folding handle (for placing motorcycle on center stand) [24]
- 13 = Dualseat lock with helmet holder [15, 25]
- 14 = Left passenger's footrest (folding)
- 15 = Left passenger's grab handle
- 16 = Storage space (accessible when dualseat is open) [15]

K 100 RT



K8 391

K 100 LT



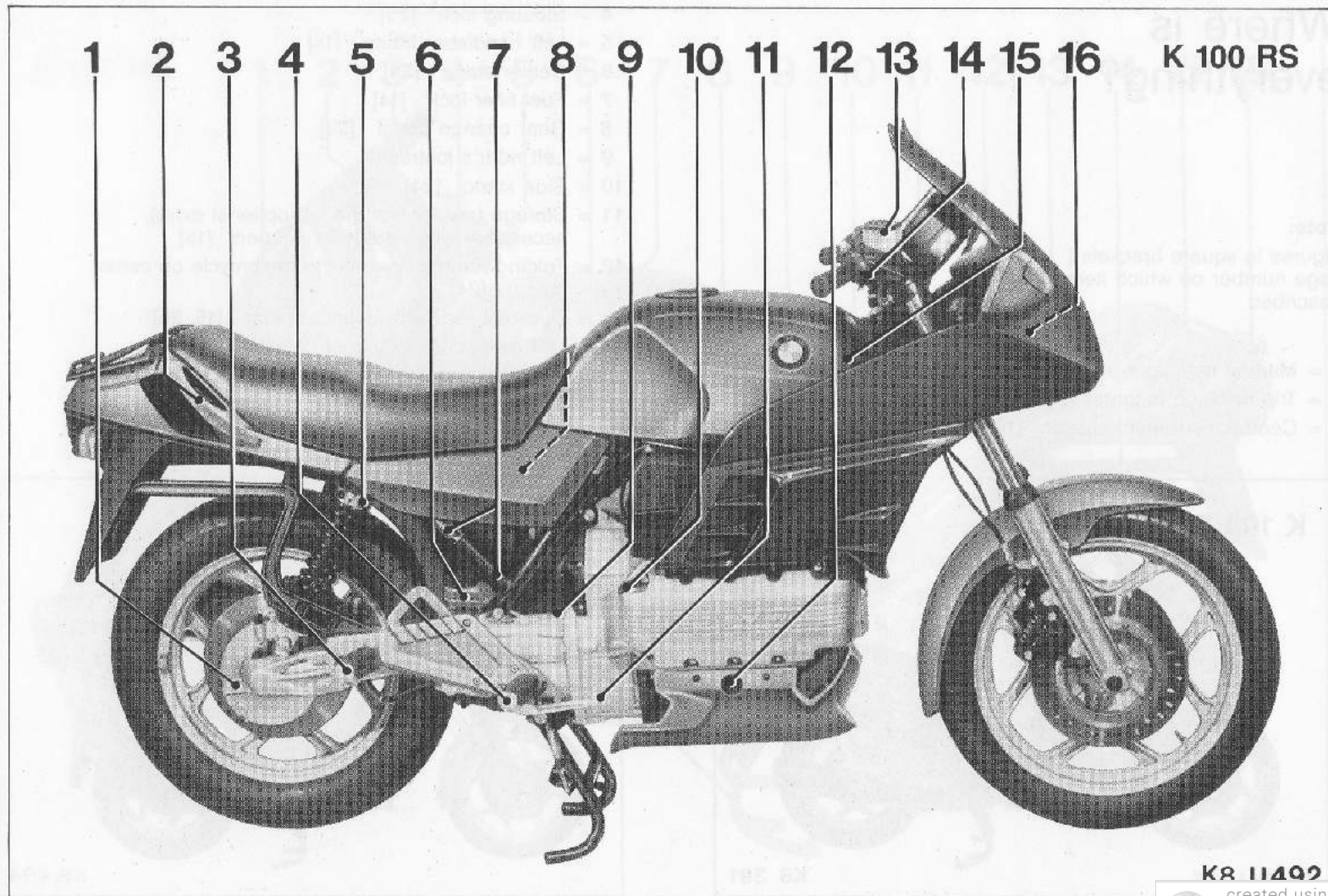

K8 11402



created using
**BCL easyPDF
Printer Driver**

[Click here to purchase a license to remove this image](#)

Where is everything?

Note:

Figures in square brackets [] = page number on which item is described

- 1 = Oil level check for rear wheel drive [85]
- 2 = Right passenger's grab handle
- 3 = Right passenger's footrest, folding

- 4 = Right rider's footrest
- 5 = Spring strut ('monoshock') adjuster [19]
- 6 = Rear brake fluid reservoir [18, 29]
- 7 = Type plate and vehicle identification number [67]
- 8 = Cooling system tank [18, 50]
- 9 = Oil level check for gearbox [84]
- 10 = Engine oil filler [83]
- 11 = Brake pedal [19]
- 12 = Engine oil level sight glass [17, 83]
- 13 = Front brake fluid reservoir [18, 29]
- 14 = Right handlebar fitting [14]
- 15 = Main coolant filler (accessible with fuel tank removed) [51–54]
- 16 = Manual headlight adjuster (K 100 RS/RT/LT) [43]

K 100 RT



K8 393

K 100 LT

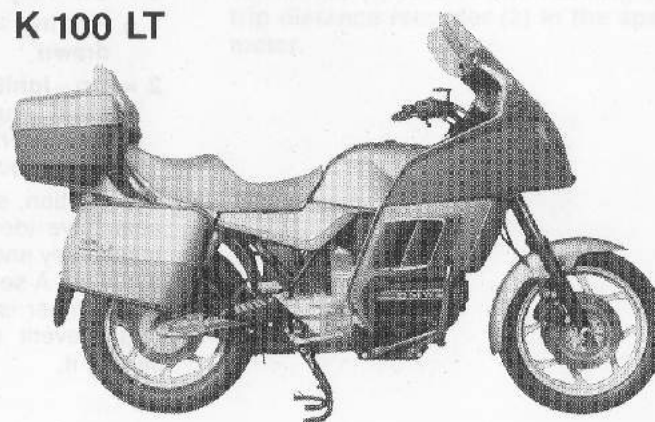

KR 495

Safety hints

Riding hints,
minor repairs

Specifications and
technical descriptions

Care and
maintenance



created using
**BCL easyPDF
Printer Driver**

[Click here](#) to purchase a license to remove this image

How does it work?

Operating instructions

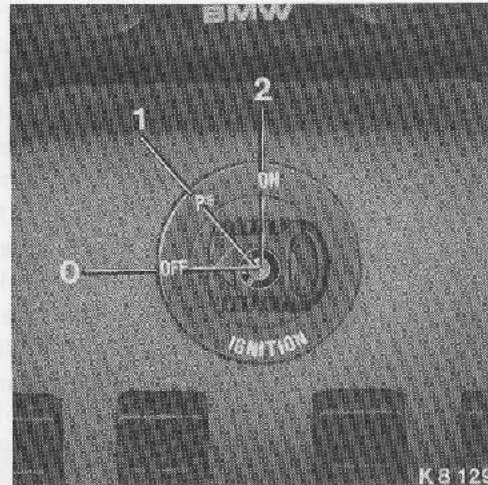

Ignition key positions

- 0 = Off – key can be withdrawn
- 1 = Parking lights – key can be withdrawn
- 2 = On – ignition and all other equipment can be operated, automatic switch-on of main beam, key cannot be removed.

The ignition, steering, fuel filler, and dual-seat have identical locks. A folding-head master key and 2 rigid-head spare keys are supplied. A self-adhesive label bearing the key number is also supplied. Keep it safe and prevent unauthorized persons from seeing it.

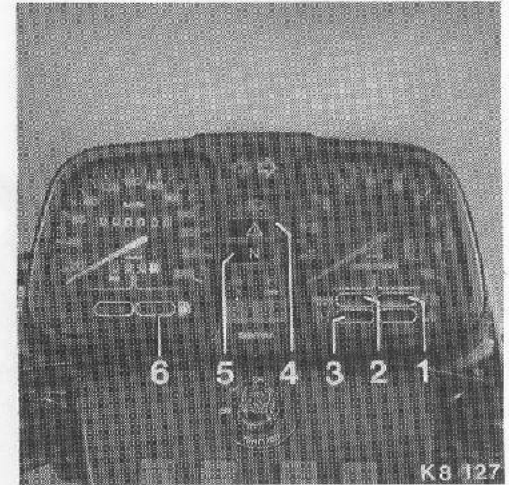

Telltale and warning lights which should come on in ignition key position "2":

- 1 = Engine oil pressure (red), see Page 22
- 2 = Battery charge (red), see Page 22
- 3 = Cold start/choke (orange) if control is operated
- 4 = Rear light monitor (red), see Page 22
- 5 = Neutral (gearbox)/idle (green)
- 6 = Less than approximately 5 liters (1.3 gal) of fuel in tank (red)

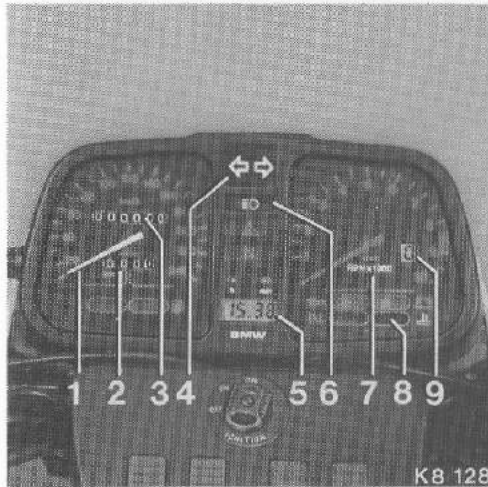

K8 128

Central instrument unit – additional functions:

- 1 = Speedometer
- 2 = Trip distance recorder
- 3 = Odometer
- 4 = Turn indicator telltale (green)
- 5 = LCD digital clock
- 6 = High beam telltale (blue)
- 7 = Revolution counter
- 8 = Coolant temperature warning light (orange), see Page 35
- 9 = Digital gear indicator

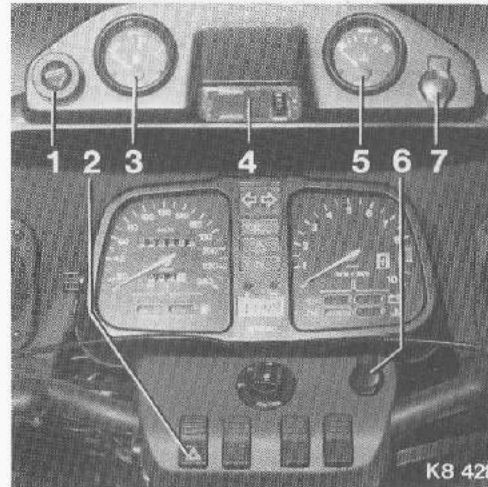

K8 428

Central instrument unit – K 100 LT

- 1 = Cigarette lighter
- 2 = Hazard warning flasher
- 3 = Fuel level indicator
- 4 = Reading lamp
- 5 = Water temperature indicator
- 6 = Plug socket I
- 7 = Plug socket II

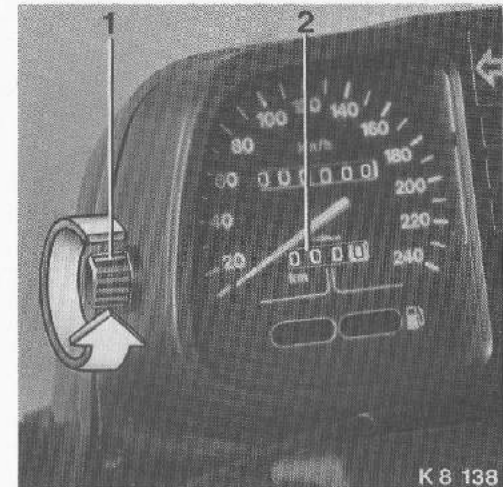

K 8 138

Resetting the trip distance recorder

Turn knob (1) to zero the reading of the trip distance recorder (2) in the speedometer.



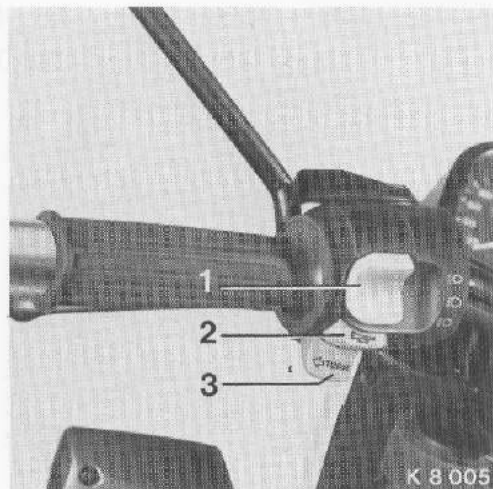

Left handlebar fitting

1 = Headlight dip switch

Up position = main (high) beam
Center position = low (dipped) beam
Down position = headlight flashing
(switch returns to center position automatically)

2 = Horn pushbutton

3 = Left turn indicator pushbutton

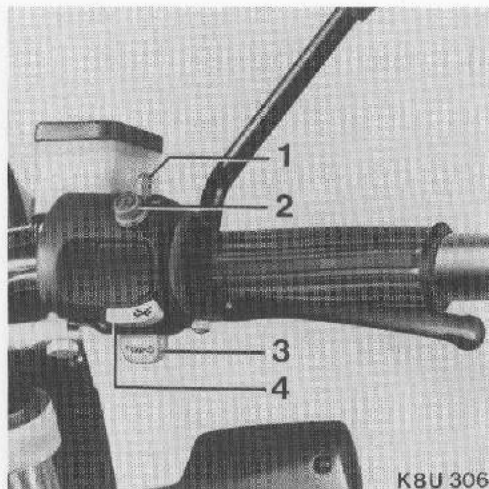

Right handlebar fitting

1 = Ignition cut-out switch

Center position: all electrical circuits live (see Page 21 for further information)

2 = Starter pushbutton

3 = Right turn indicator pushbutton

4 = Turn indicator cancelling switch: press to cancel left or right turn indicators

The left or right turn indicators are cancelled automatically after a certain time or distance if this is not done by pressing switch "4":

- after approximately 10 seconds at main-road speeds – above approximately 30 miles per hour or 50 km/h, or
- after approximately 210 m (690 ft) in local or slow-moving traffic.

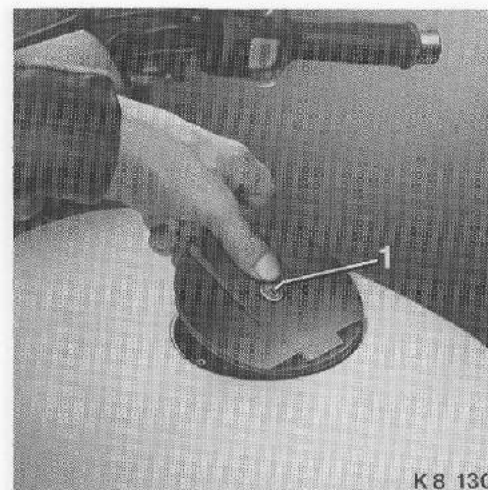

Adding fuel

Warning:

Turn your head from fuel cap when opening. Fuel tank operates under a low pressure.

Unlock the filler cap (1) (all locks on the motorcycle can be opened with the same key); insert key, turn counter-clockwise $\frac{1}{4}$ revolution, the cap springs up automatically and the key can be removed.

After adding fuel, ensure that the cap is closed securely by pushing the cap down until a "click" is heard to lock it.

Remember that fuel expands if it becomes warm; for this reason do not fill the tank to the brim.



created using
**BCL easyPDF
Printer Driver**

[Click here to purchase a license to remove this image](#)

Warning:

Gasoline is extremely flammable and is explosive under certain conditions. Refuel in a well-ventilated area with the engine stopped. Do not smoke or allow flames or sparks in the area where the motorcycle is refueled or stored.

Do not overfill the tank (there should be no fuel in the filler neck). After refueling, make sure the tank cap is closed securely.

Use leaded or unleaded gasoline, minimum 91 ROZ. Fuels containing ethanol or other oxygenates (e. g. ethers and ketones) or methanol may cause driveability, starting and stalling problems.

Fuel additives are not recommended.

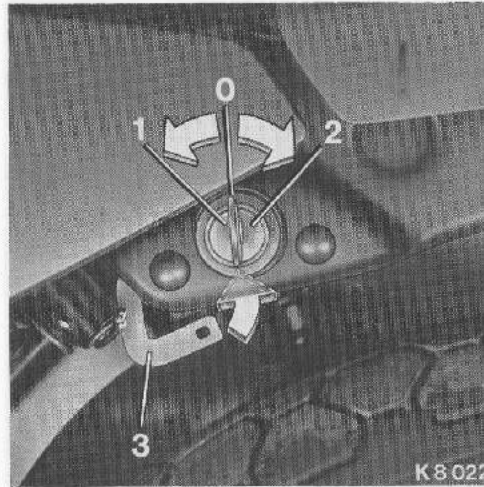
**Dualseat lock**

Position 0 = Dualseat locked

Position 1 = Dualseat can be opened by pressing in dualseat lock

Position 2 = Press the lock in to open the helmet holder (3)

The dualseat can be closed and locked with the key removed. The helmet holder must be locked by moving it in the direction of the arrow.

**Storage space under dualseat**

Open the dualseat. After removing the covers, access is gained to the

- Storage tray = 2.2 l (0.52 gal.) capacity
- Large storage compartment in tail panelling = 9.0 l (2.13 gal.) capacity.

Lighter items can be kept in the storage tray, e. g. first aid kit (optional extra), and the tools, documents and possibly a rain-suit stowed in the large compartment.





Storage compartments K 100 RT/LT

Additional storage compartments are provided in both sides of the fairing on the K 100 RT/LT.

The covers, which can be unlocked with the master key, may be stored away while loading:

- Put cover into spring-loaded fixation (1) and push into indicated direction,
- fix cover against spring load at hook (2).

Warning:

Never ride motorcycle with cover in loading position, as a loose cover may fall down and lock the steering, causing an accident.

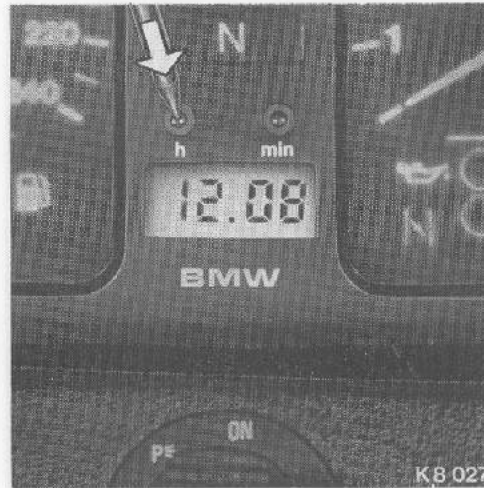

LCD digital clock

To reset the time, use a rounded, pointed object (such as a ball point pen tip) to press lightly on the rubber-covered, adjusting points above the clock display:

- “h” = hours adjuster
- “min” = minutes adjuster



Adjusting the spoiler at the windscreen – K 100 RS

Depending on the size and seated position of the rider, the air stream at helmet height can be redirected with the adjustable spoiler.

Find the best position by trial and error after releasing the retaining screws (arrows) with a coin:

- steeper position = wind deflected higher
- flatter position = wind deflected lower.



created using
**BCL easyPDF
Printer Driver**

[Click here to purchase a license to remove this image](#)

Safety checks before you start

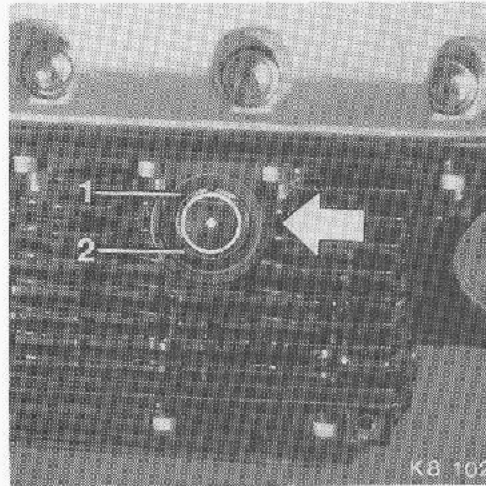

Engine oil level

There is an oil level sight glass on the lower part of the engine block. Oil level at: 1 = maximum 2 = minimum

Quantity of oil between maximum and minimum marks = 0.6 liter (approximately 1/2 quart). Adding oil beyond the maximum mark has practical disadvantages in the form of increased consumption and possibly oil leakage.

Caution:

Never allow the oil level to drop below the minimum mark.

Regular oil level checking

Position the motorcycle on its center stand on a flat, level surface. Run the engine for a short time at normal operating temperature and then switch it off. Check the oil level after waiting a few minutes.

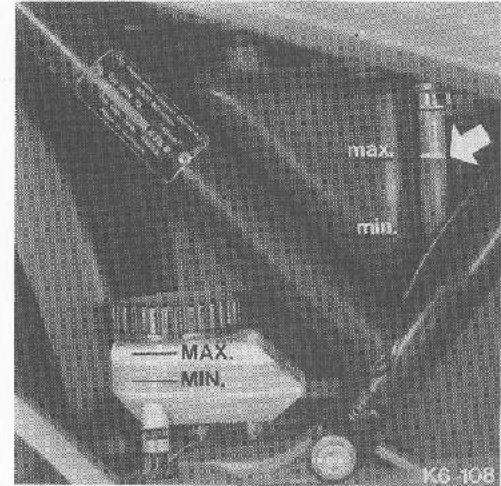

Coolant level

Read off at the transparent level-check pipe at the coolant tank (arrow), when the coolant is cold

If necessary, add coolant up to the maximum mark – for instructions, see Page 60.



created using
**BCL easyPDF
Printer Driver**

[Click here to purchase a license to remove this image](#)

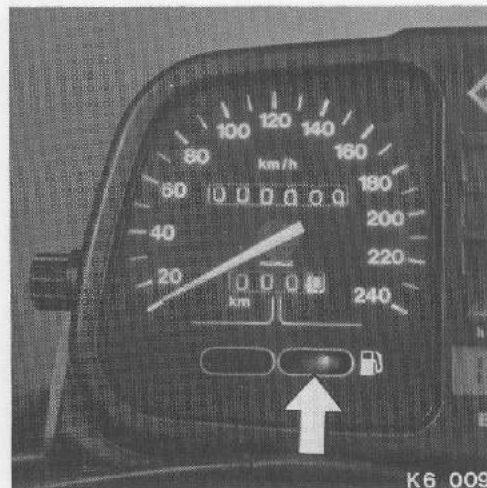

Fuel level

The low fuel warning light (arrow) comes on when approximately 5 liters (1.3 gal.) of fuel remain in the tank.

The fuel tank holds a total of 19.5 liters (5.2 gal.). After the motorcycle has been broken in, determine how far it can normally be ridden with the low-level light on (this will depend on your riding style).

Warning:

Never ride the motorcycle with cover in riding position, as a loose cover may fall down and lock the steering, leading to an accident.



Front brake fluid

The brake fluid level can be seen at the transparent reservoir. Note the maximum and minimum markings.

Warning:

Never allow the brake fluid level to drop below the minimum marking.

To add brake fluid, take out the three Phillips-head screws and take off the cover with rubber diaphragm.

Use only fresh brake fluid to DOT 4 "SL" specification (ATE or equivalent).

Caution:

Brake fluid attacks painted surfaces.

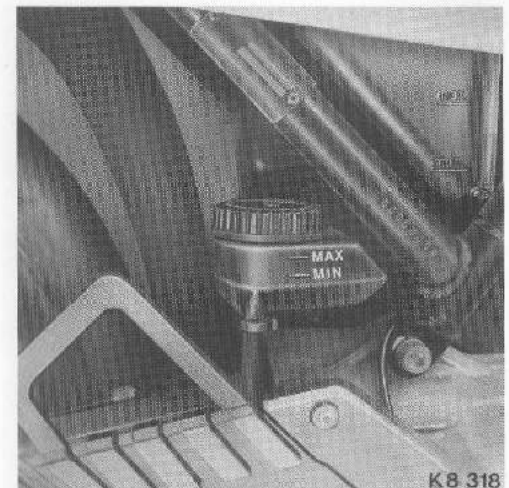

Rear wheel brake fluid

Level checking: similar procedure to front brake (see previous column).

However, to add fluid unscrew the reservoir cover by turning it anticlockwise.



created using
BCL easyPDF
Printer Driver

[Click here to purchase a license to remove this image](#)

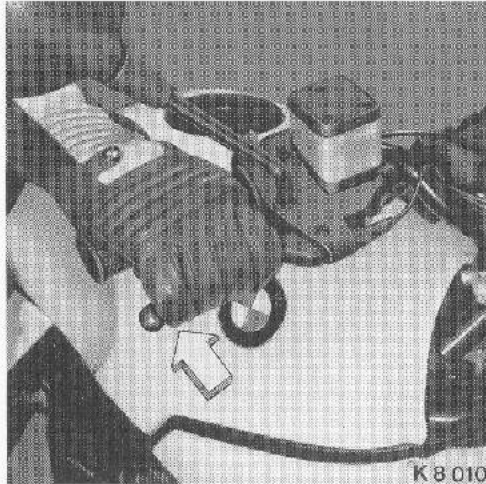

K 8 010

Checking handbrake lever

The free travel of the brake lever is fixed and must not be modified.

Warning:

Sudden changes in the amount of free travel or a spongy feeling at the brake lever are signs of possible malfunctions in the hydraulic system.

In this event, see your BMW dealer or qualified service technician immediately.

The same applies to the foot brake, the factory setting of which must not be altered.

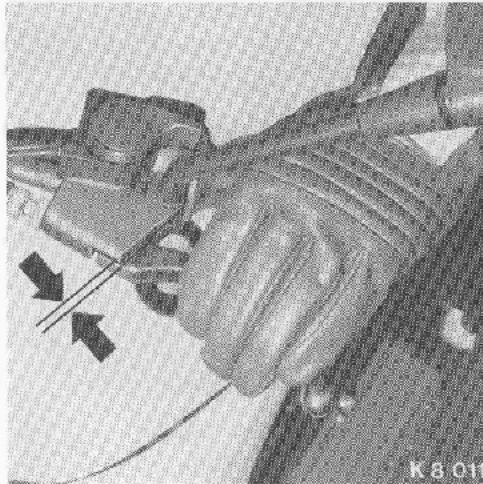

K 8 011

Checking clutch lever

Free travel at the clutch lever should be $4 + 0.5 \text{ mm}$ ($0.16 + 0.02 \text{ in.}$).

Normal clutch plate wear leads automatically to a reduction in free travel. This should be corrected during a BMW Inspection.

In an emergency, the basic setting can be adjusted as described on Page 54.

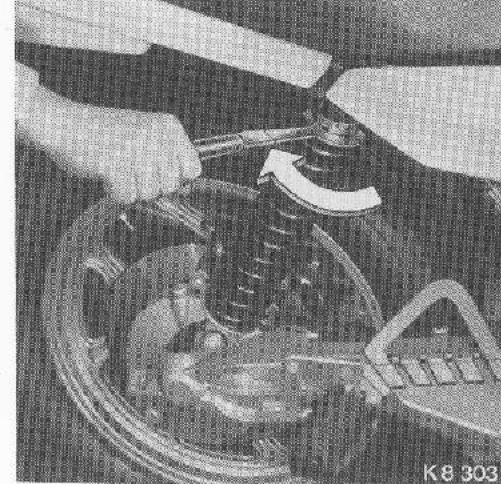

K 8 303

Spring strut ('monoshock') adjustment

Using the hook wrench with extension from the motorcycle's toolkit, coil spring preload for the rear suspension can be tightened to one of three settings, according to operating conditions:

- Normal spring setting = for solo riding
- Medium spring setting = with passenger or heavy luggage
- Hard spring setting = for maximum loads



Nivomat (optional extra)

The Nivomat does not have to be operated by the rider to ensure a consistently high standard of roadholding and handling under all load and road conditions.

The correct ride height setting is achieved automatically shortly after commencing a journey.

Advantages:

- Consistent spring travel independent of load
- Load-dependent damping
- Ground clearance always remains the same
- Headlight beam throw needs no adjustment

Warning:

Never open a Nivomat because of extremely high pressure.

Checking tire pressures

Check tire pressures regularly to ensure optimum roadholding and extended tire life.

(See Page 69 for correct tire pressures, and Page 28 for further information.)

Checking lights

Check operation of the various lights before each journey:

- Dipped-beam headlight
- High-beam headlight
- Rear light
- Brake light (handbrake and foot brake)
- Flashing turn indicators



created using
**BCL easyPDF
Printer Driver**

[Click here](#) to purchase a license to remove this image

On the road: starting – riding – parking

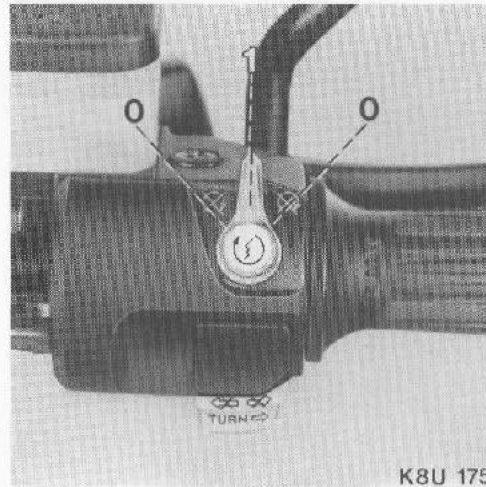

K8U 175

Before starting the engine:

Move the ignition cut-out switch to position "1" to energize all electrical circuits.

The engine can only be started in the central position (1) of the cut-out switch, which interrupts the electric power supply to the ignition, fuel injection, fuel pump and starter motor when it is moved either to the left or the right.

If you have to stop the engine immediately in an emergency situation, move the switch either left or right to one of the two "0" positions. If the motorcycle is in motion, disengage clutch and brake to a safe location.

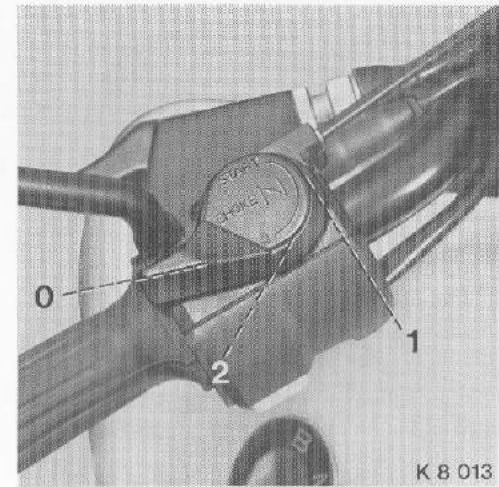

K 8 013

Starting a cold or warm engine

Depending on engine or ambient temperature, the choke (increased cold starting speed) lever may have to be used:

- Position 1 = below 10° C (50° F)
- Position 2 = above 10° C (50° F)
- Position 0 = when engine is at normal operating temperature.

If necessary, operate the throttle twistgrip gently.

At ambient temperatures below 0° C (32° F), disengage the clutch when starting the engine.



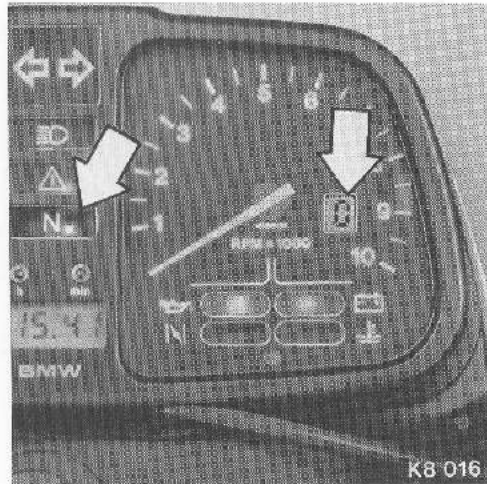

While in neutral, switch on the ignition.

- The "N" telltale light will come on
- The digital gear indicator is at "0"

The digital gear indicator in the revolution counter shows which gear is selected.

Press the starter button. The engine will start.

Move the choke lever gradually back to "0" as the engine runs more smoothly.

Note:

Attempting to start the engine with a flat battery will cause damage to the starter relay.

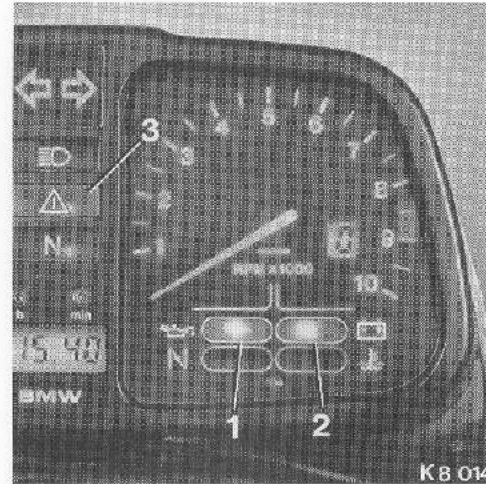

After the ignition has been switched on, the following telltale and warning lights are illuminated:

- 1 = Engine oil pressure
- 2 = Battery charge (alternator)

Both these lights must go out after the engine has been started and is running at idle speed.

Caution:

If oil pressure warning light (1) stays on, disengage clutch immediately and shut off the ignition and consult a qualified service technician.

Correct battery charging is also indicated by the charge telltale light (2) going out above engine idle speed.

If the charge telltale light comes on during the journey, take the motorcycle to a qualified service technician as soon as possible, or else the battery will go flat.

3 = Rear light monitor "△"

Switch on the ignition and the parking lights. If this telltale light goes out when the handbrake and foot brake are applied, the tail and brake lights are in correct working order.

The telltale light remains "on" if a bulb or a switch is faulty or a circuit interrupted as a reminder to rectify the problem.

Note:

If the rear brake light should fail during a trip, the light monitor "△" will light up immediately.

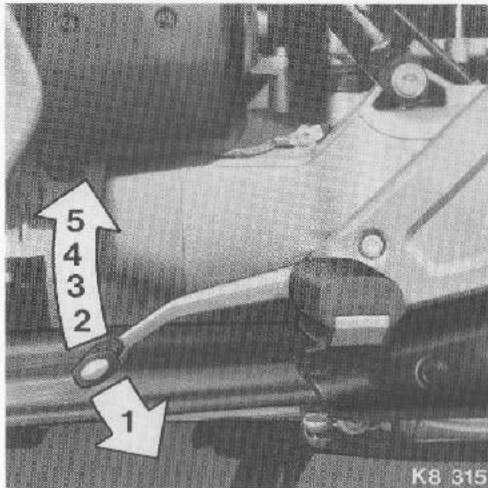

Gear changes

The gear shift pedal has a certain amount of position adjustment, to suit the rider's foot position and size.

Warning:

For your own safety – be certain the gear shift lever is in the neutral position (the digital gear indicator is at "0") before starting the engine.

To move from a standstill: from neutral pull in the clutch lever and select 1st gear by pressing down the gear shift pedal.

Release the clutch lever gradually, increasing engine speed to the necessary extent at the throttle twistgrip. The motorcycle will begin to move. Vary your speed with the throttle, not by slipping the clutch.

As speed rises, shift up to 2nd, 3rd, 4th and 5th gears in a similar way.

To down-shift, close the throttle, disengage clutch and select the next lower gear. Engage the clutch again smoothly and alter the throttle opening.

Warning:

On wet and slippery roads in particular, sudden changes in transmission load can cause rear wheel slippage and can result in an accident.

If engine speed drops below 1500 rpm during normal riding, select a lower gear.





Removing motorcycle from center stand

With the left hand on the left handlebar grip and the right hand on the folding handle, push the motorcycle forward until the center stand is able to fold up.

Placing motorcycle on center stand (left picture)

Press the center stand down at the projecting lever until both skids are touching the ground. With the left hand on the left handlebar twistgrip and the right hand on the folding handle, transfer body weight to the right foot (on the stand lever) and pull the motorcycle upward and back so that the stand is able to extend fully.

Placing motorcycle on side stand (right picture)

Extend the side stand fully forward by means of its extension arm, and allow the motorcycle to tilt slowly to the left until the stand takes its weight.

The side stand will fold up automatically when the motorcycle's weight is released and the clutch lever on the handlebar is pulled.

Caution:

On a slope, do not use the side stand unless the front of the motorcycle is pointing uphill. If necessary, select 1st gear to lock the rear wheel as well.

Make sure that the stands rest on a firm surface, to avoid the risk of the motorcycle falling over.

Do not operate the clutch lever while the side stand is used, or else the side stand retraction mechanism could be damaged.

Warning:

Before riding away, be sure the side stand is folded up correctly to avoid an accident.

K B 019

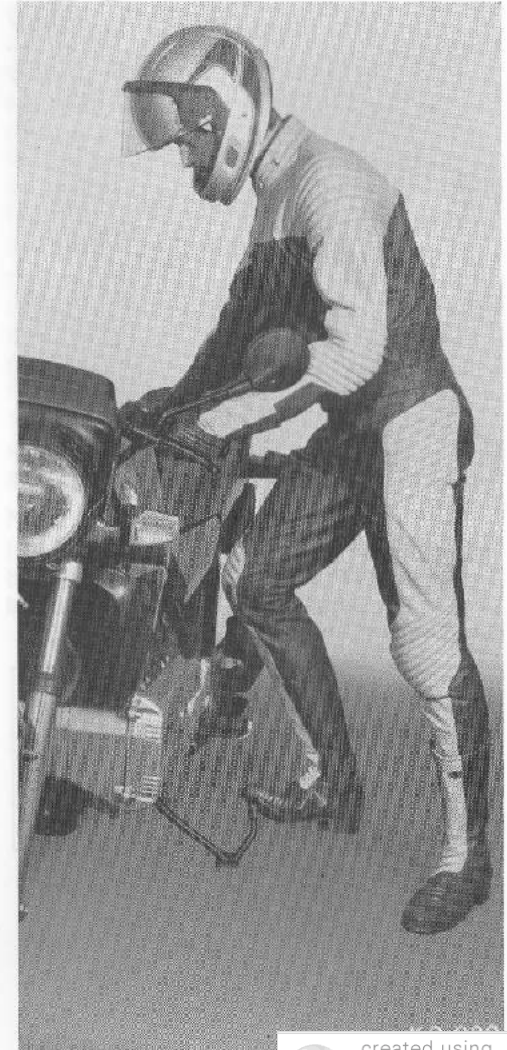

created using
**BCL easyPDF
Printer Driver**

[Click here to purchase a license to remove this image](#)

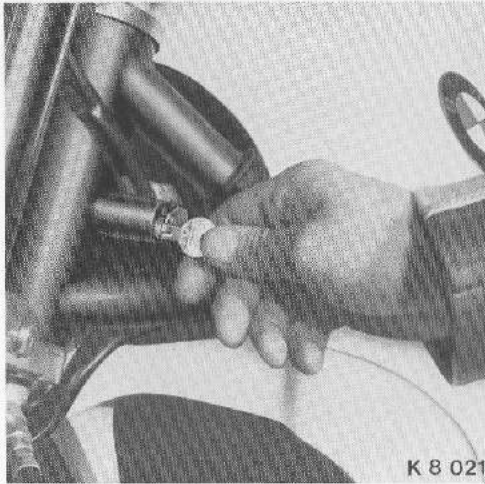

K 8 021

Locking the steering to prevent unauthorized use of the motorcycle

Swing the protective cover over the lock to the right (K 100).

Insert the key and turn to the left. Move the handlebar to the right of center so that the lock can engage. Then turn the key to the right to operate the lock, and remove the key.

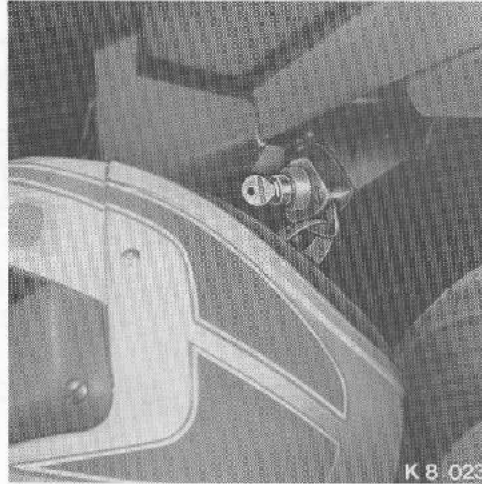

K 8 -023

Helmet holder

The picture shows one of the ways in which the helmet can be left secured to the parked motorcycle yet protected against theft.

Depending on helmet pattern and chin-strap length, it may be possible to secure two helmets to the holder.

Warning:

Never operate your motorcycle with a helmet locked in the helmet holder, as it may interfere with the rear wheel, causing an accident.

For operation of the dualseat lock, see Page 15.



created using
**BCL easyPDF
Printer Driver**

[Click here to purchase a license to remove this image](#)

Electronic Burglar Alarm (Optional BMW Accessory)

As well as safeguarding the parked motorcycle by operating the steering and dualseat locks, and perhaps by using a padlock, the electronic burglar alarm provides even greater protection against theft.

With the system "energized", the following occurrences will cause the horn to sound intermittently for up to 30 seconds:

- Switching on the ignition
- Short-circuiting the ignition switch
- Starting the motorcycle with another battery
- Disconnecting the battery; the alarm horn then sounds (95 dBA)
- Disconnecting the motorcycle horn; the alarm horn then sounds after a time delay
- Any movement of the motorcycle around its longitudinal axis
- Rough handling of the motorcycle
- Opening the dualseat

The alarm sounds for a maximum of 30 seconds, even when more than one of the above situations occur at the same time. After 30 seconds, repeated attempts to tamper with the motorcycle will cause the alarm to sound again.

The motorcycle must be resting on its center stand when the burglar alarm is energized.

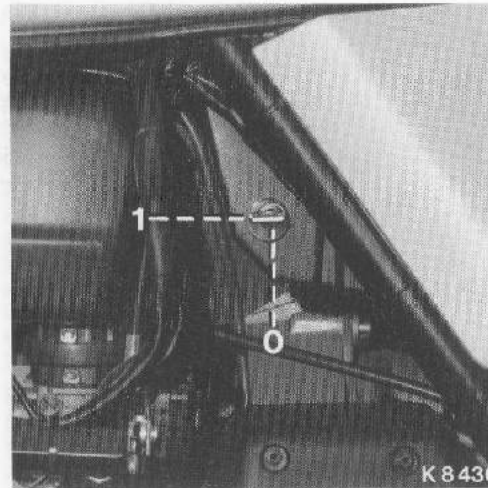

Switching the burglar alarm on and off
The key switch for switching the system on and off is located in a slightly setback position in front of the left-side battery cover:

Position 0 = System switched off

Position 1 = System energized.

The key can be removed in either position and should be kept safely together with the main motorcycle key.

Note:

Alarm system is fused at the main fuse block on location # 5 (see page 47).

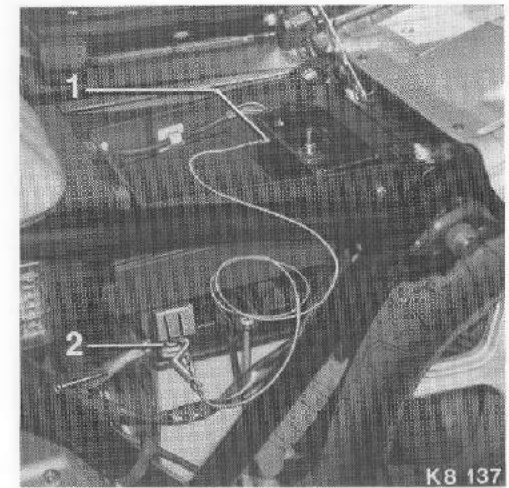

Power supply to the alarm horn from the NiCd accumulator in the control unit

The accumulator is continuously charged by the motorcycle battery (when installed). If the motorcycle battery is disconnected or removed, the accumulator charge is sufficient for 30 days (longer in ignition switch position 1). However, an "electronic interlock" prevents the horn sounding if the motorcycle is merely handled roughly.

A charging cable is provided so that the accumulator can be recharged in 12 to 14 hours with the motorcycle battery installed, if this should be necessary:

- Connect the mini plug to the charge socket on the control unit (1)
- Connect the clip to the motorcycle battery positive terminal (2)



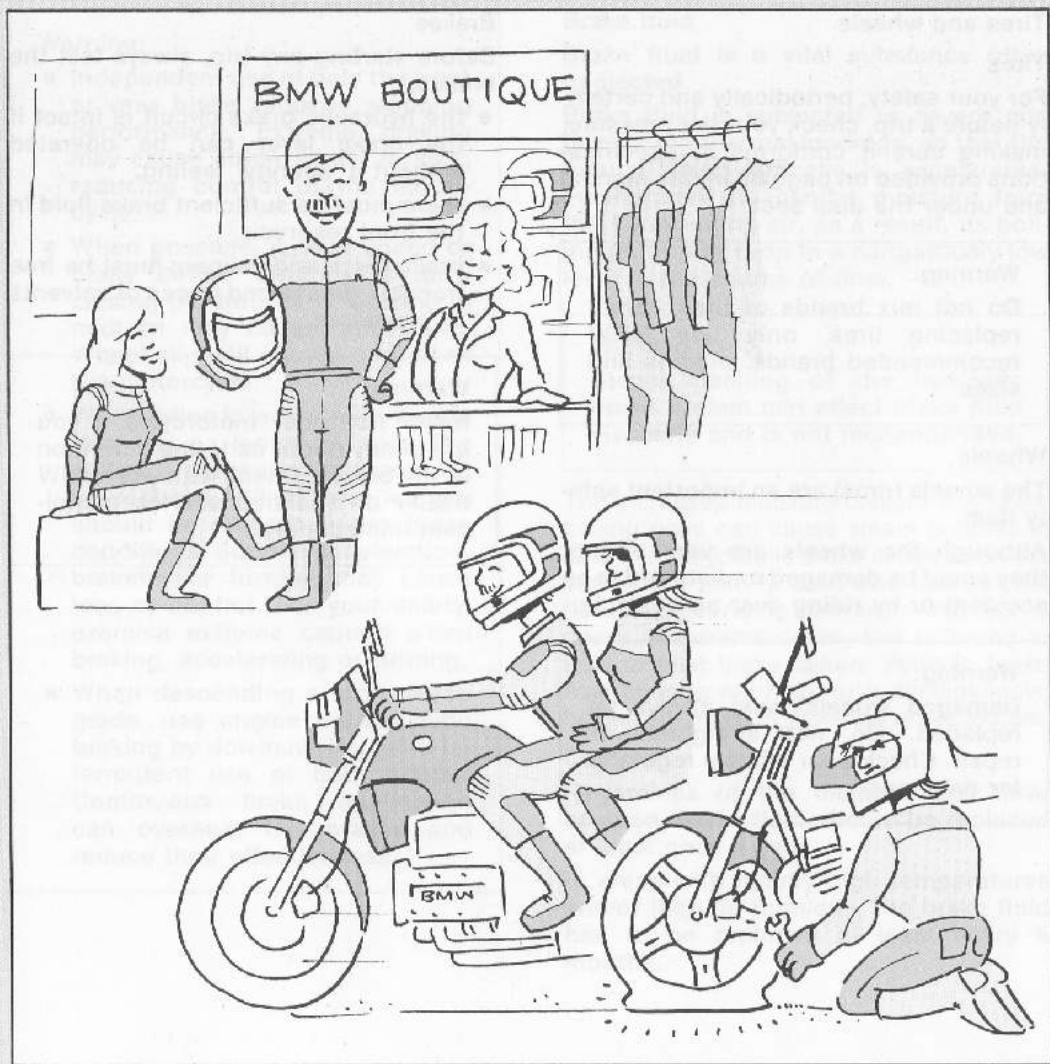

Prevention is better than . . .

Safety hints relating to the motorcycle:

- Condition of motorcycle
- Tires and wheels
- Brakes
- Brake fluid
- Lights
- High-performance ignition system

Safety hints concerning the rider:

- Long journeys
- Clothing
- Safety helmet
- Radio/cassette player



Always think of your own safety, that of your passenger's and other's.

Note:

A full safety check before you start is essential!

Condition of motorcycle
(leave nothing to chance!)

Entrust your motorcycle regularly to a qualified service technician, who is competent to provide quality service using proper parts and practices so that the recommended BMW maintenance program can be carried out correctly.

Tires and wheels

Tires

For your safety, periodically and certainly before a trip, check your tire pressure, making sure it conforms to specifications provided on page 69 in this manual and under the dual seat.

Warning:

Do not mix brands of tires. When replacing tires, only use BMW recommended brands, models and sizes.

Wheels

The wheels (rims) are an important safety item.

Although the wheels are very strong, they could be damaged or distorted in an accident or by riding over an obstacle.

Warning:

Damaged wheels must always be replaced. Do not straighten or repair. Check your wheels regularly for damages.

Brakes

Before starting any trip, always test the brakes:

- the hydraulic brake circuit is intact if the brake lever can be operated without a 'spongy' feeling.
- there must be sufficient brake fluid in the front reservoir.
- brake discs and calipers must be free from oil, grease and traces of solvents of cleansers.

Warning:

Never ride your motorcycle if you are in any doubt as to the condition of the brakes. Check with your BMW dealer or qualified service technician immediately.



Warning:

- Independent use of only the front or rear brake reduces stopping performance. Extreme braking may cause either wheel to lock, reducing control of the motorcycle.
- When possible, reduce speed or brake before entering a turn; closing the throttle or braking in midturn may cause wheel slip. Wheel slip will reduce control of the motorcycle.
- When riding in wet or rainy conditions, or on loose surfaces, the ability to maneuver and stop will be reduced. All of your actions should be smooth under these conditions. Sudden acceleration, braking, or turning may cause loss of control. For your safety, exercise extreme caution when braking, accelerating or turning.
- When descending a long, steep grade, use engine compression braking by downshifting, with intermittent use of both brakes. Continuous brake application can overheat the brakes and reduce their effectiveness.

Brake fluid

Brake fluid is a vital substance often neglected.

Brake fluid is subjected to severe and fluctuating thermal loadings, so that the natural aging process is accelerated. Furthermore it absorbs moisture from the surrounding air; as a result, its boiling point may drop to a dangerously low level in the course of time.

Warning:

Steam cleaning of the hydraulic brake system can affect brake fluid viscosity and is not recommended.

The increased moisture content and lower boiling point can cause steam bubbles to form in the hydraulic brake circuit when the brakes are heavily used and become hot (for instance, riding downhill in too high a gear). In extreme cases, this is bound to lead to total brake failure. Periodic brake fluid change will help flush contaminants, held in suspension, from the brake system.

Caution:

Regardless of the distance you have covered, brake fluid should be replaced at least once a year.

In areas with mainly high temperatures and/or high air humidity, the brake fluid has to be replaced at least every 6 months.

Lights

Before starting the engine, it is good practice to **check operation** of the

- parking light
- low (dipped) headlight beam
- main (high) headlight beam,

by holding a hand in front of the headlight lens.

As you have read on page 22, the tail and brake lights can be checked at monitor "△".

Pay special attention to condition of the turn indicators:

Turn indicator bulbs have to withstand severe loadings. A blown or damaged bulb can normally be detected by the increased flashing frequency of the repeater light, and should be repaired or replaced immediately.

High-performance ignition system

Even on conventional ignition systems with breaker points, an electrical shock could be quite unpleasant.

On this motorcycle's ignition system, however, much greater care has to be taken.

The motorcycle is equipped with a microprocessor-controlled high-performance digital ignition system.

Warning:

A dangerous or even fatal accident could be caused by touching any live component when the engine is running.



created using
**BCL easyPDF
Printer Driver**

[Click here to purchase a license to remove this image](#)

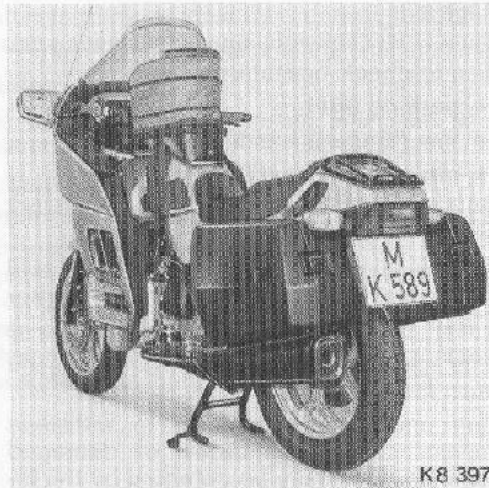

Long journeys

BMW integral saddlebags

BMW topcase

BMW tank-top rucksack

BMW servicing and repair accessories

Even motorcyclists on long journeys can look their best when the day's run is over: there is ample provision for carefully planned storage space.

With the aid of BMW integral saddlebags, the BMW topcase the BMW tank-top rucksack and the BMW luggage carrier (all optional extras or Genuine BMW accessories), far more than just minimum changes of clothing can be carried on the motorcycle.

Warning:

Handling and stability of your motorcycle can be adversely affected by a number of factors.

In particular, excessive or unbalanced loading and the use of accessories not approved by BMW can lead to dangerous deterioration of the handling and stability characteristics of your motorcycle and thereby cause an accident.

For your safety and the safety of others:

- DO NOT exceed a maximum load per saddlebag of 22 lbs. (10 kg).
- DO NOT exceed a maximum load on the luggage carrier of 11 lbs. (5 kg).
- DO NOT exceed a maximum load of 33 lbs. (15 kg) in the top case.
- DO NOT exceed a maximum load of 11 lbs. (5 kg) in the city case.
- DO NOT load bulky and/or heavy items on your luggage carrier which is designed to carry small, light luggage only.
- DO NOT let luggage items project beyond the back of your motorcycle.
- DO NOT distribute the weight of your luggage unevenly.

- DO NOT carry items which, due to their size or shape or the way they are secured on the motorcycle, can interfere with ground clearance, cornering angles, front and rear suspension travel, etc.
- DO NOT, however, secure these items higher than necessary to comply with the preceding point lest your motorcycle's center gravity is unnecessarily raised.
- DO NOT secure luggage so loosely as to create the danger of it shifting suddenly or falling off. Check regularly if luggage continues to be securely fastened.
- DO NOT exceed a speed of 80 mph with saddlebags and/or a luggage carrier installed even if there is no legal speed limit for the road you are riding on.
- DO NOT exceed a speed of 100 mph with wind screen installed even if there is no legal speed limit for the road you are riding on.
- DO NOT use your motorcycle with a sidecar or for towing a trailer. It is not designed for these purposes. Also, BMW does not offer any accessories for these purposes.



created using
BCL easyPDF
Printer Driver

[Click here to purchase a license to remove this image](#)



K8 320



K8 321



E 88 018

The motorcycle helmet – or even better: the BMW “System Helmet”

Your helmet should satisfy official test regulations and be a comfortable fit, so that you can wear it for long periods if necessary!

The “System Helmet” supplied as a Genuine BMW Accessory is particularly versatile: it can be worn in several different ways:

- The visor – also available in a anti-fog and tinted version – has a detent mounting and can easily be repositioned to within fine limits.
- Press-button catches at left and right enable the chinguard with visor to be folded up completely – useful for eye-glass wearers.
- For riding in bright sunlight, the standard visor can be replaced by a special version in just a few easy operations. Ideal for the off-road rider.

As a safety precaution, renew a scratched visor promptly. It is good practice to carry a spare visor along.

The BMW System Helmet represents a purposeful further development with regard to aerodynamics and fresh-air ducting.

The new fresh-air ventilation system ensures optimum air circulation inside the helmet and reduces visor fogging at all speeds.

Improved aerodynamics reduce the level of noise inside the helmet and improve directional stability, particularly at high speed.

Warning:

Never operate your motorcycle with a helmet locked in the helmet holder, as it may interfere with the rear wheel, causing an accident.

Riding hints,
minor repairs

Specifications and
technical descriptions

Care and
maintenance

Technical
index



created using
**BCL easyPDF
Printer Driver**

[Click here to purchase a license to remove this image](#)

Clothing

What remains? The leather riding suit, rounded off by high-quality leather gloves and boots, with the well-known wearing comfort. Or do you prefer wearing a multipurpose riding suit?

This is normally rainproof, but able to 'breathe'. Special heat-retaining material provides effective protection against cold weather, so that the more determined enthusiast can take to the road in any season of the year.

And those who appreciate that there's more to relaxed, comfortable riding than meets the eye, will wear the proper motorcycling underclothing too.

Light, single-piece rainsuits protect expensive leather clothing and keep the rider dry. Rubber overshoes and rain gloves complete the outfit.

All these additional items can be folded or rolled up compactly and easily stowed.

Do you need riding gear for yourself or your passenger?

Look no further than your local BMW motorcycle dealer. You will be amazed at the range of Genuine BMW Accessories to choose from.

BMW Perfection in Detail – with every item produced and tested for you by the experienced motorcyclists in the BMW design team.



Radio and cassette player – K 100 RT

In certain riding and operating conditions, this BMW accessory can further enhance the pleasure of (restrained) motorcycling. Of course, you should always pay due regard to the environment, other road users and pedestrians.

As in Germany, certain legal requirements, such as the following, may apply.

“The person in charge of the vehicle and other road users must in no way be distracted or disturbed in such a way as to create a danger or nuisance.”

Such legislation can be interpreted fairly freely, but the law-enforcing authorities may be stricter than you had anticipated. You should be careful to avoid any confrontation.

Note:

The radio system is located in a protected position so that it cannot be affected by moisture when riding or at a standstill. When cleaning the motorcycle, however, be sure to prevent water being sprayed directly on to the appliance.

Always keep cassettes in their boxes when not in use, or else vibration may cause them to become tangled.

Caution:

For safety reasons, you should avoid adjusting the set while the motorcycle is in motion.



created using
**BCL easyPDF
Printer Driver**

[Click here to purchase a license to remove this image](#)

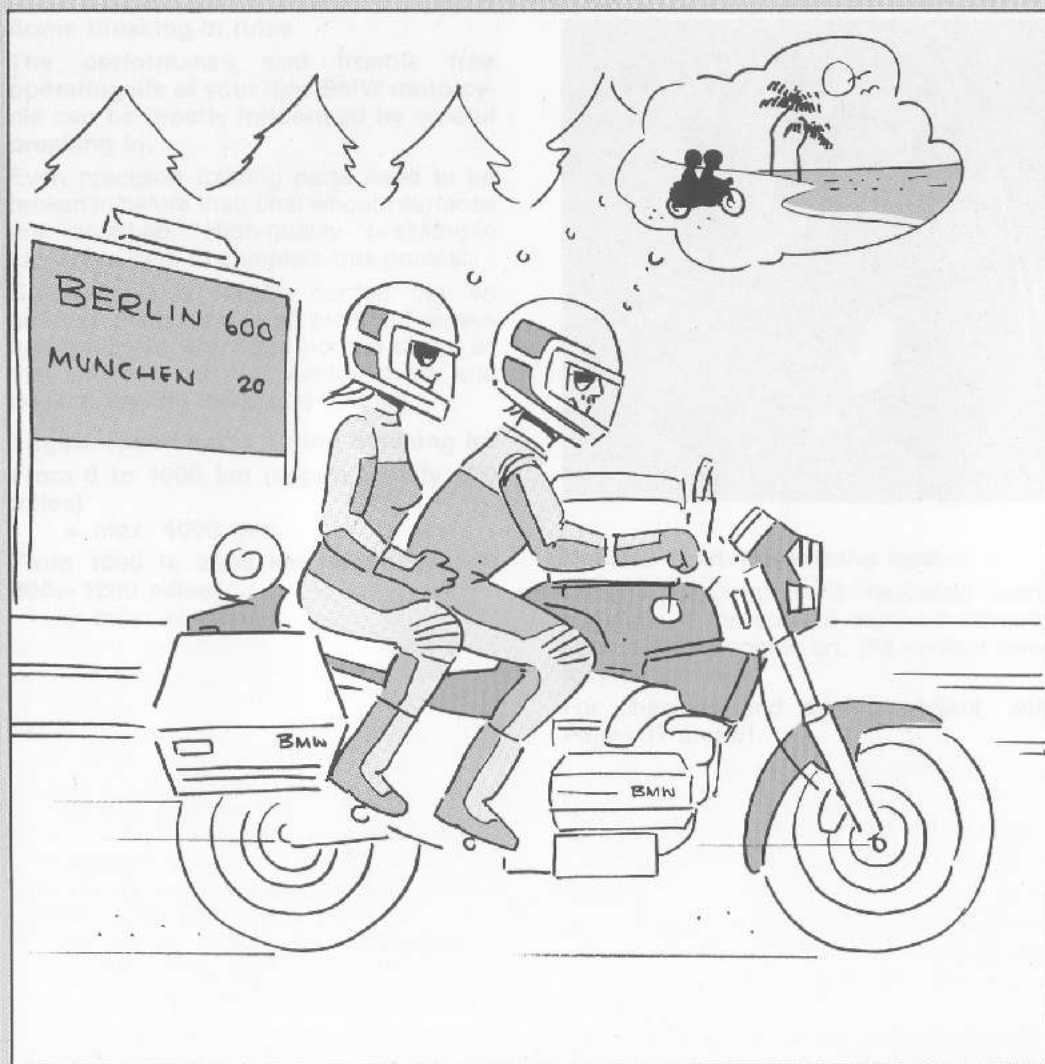

Aim for perfection – and enjoy trouble-free riding

- Some breaking-in rules
- Do-it-yourself minor repairs:
 - Changing wheels
 - Tire repairs
 - Replacing bulbs and fuses
 - Adjusting headlight beam
 - Replacing fuses
 - Replacing spark plugs
 - Checking spark-plug appearance
 - Adjusting coolant level
 - Replacing coolant (after taking off fuel tank)
 - Adjusting clutch
- What to do if . . . (troubleshooting)
- What not to do (limits of do-it-yourself repairs)
- Technical modifications

Riding hints,
minor repairs

Specifications and
technical descriptions

Care and
maintenance

Referral
Index



created using
**BCL easyPDF
Printer Driver**

[Click here to purchase a license to remove this image](#)

Some breaking-in rules

The performance and trouble free operating life of your new BMW motorcycle can be greatly influenced by careful breaking in.

Even precision rotating parts need to be broken in before their final smooth surfaces are obtained. High-quality breaking-in lubricants help to complete this process.

Breaking in is ideally carried out on ordinary main roads with plenty of curves and gradients which are not too steep, so that you can use the various gears and drive at varying loads and torques.

Engine speed limits during breaking in:

From 0 to 1000 km (approximately 600 miles)

= max. 4000 rpm

From 1000 to 2000 km (approximately 600 – 1200 miles)

= max. 4500 rpm.

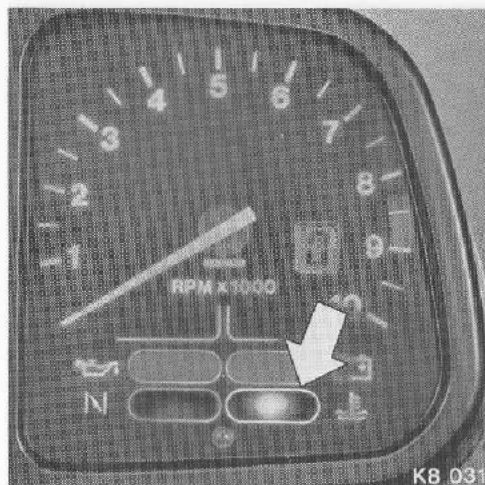

Coolant overheat warning light

Coolant temperature is regulated automatically. If the coolant overheat warning light (orange) comes on, the coolant level may be too low.

For checking and adding coolant, see Pages 17 and 51.

Above an odometer reading of 2000 km (approximately 1200 miles), you can gradually increase the engine speed of your BMW motorcycle to the maximum permitted value whenever road and traffic conditions permit.

Until about 500 km (approximately 300 miles) have been covered, do not subject brakes to lengthy endurance tests. Brake pads also have to be bedded in if they are to achieve their most favorable friction coefficients and minimum rate of wear.

The tires must also be broken in, over a distance of approximately 500 km (300 miles). You cannot be sure of proper road adhesion until this distance has been covered.

After 1000 km (600 miles), the first inspection is due. In addition to oil changes, various important maintenance and adjustment work is performed on your BMW motorcycle by a qualified service technician, and is essential to insure maximum reliability at a later date. Ensure that all service/maintenance work performed on your motorcycle is recorded in the Proof of Ownership/Service History booklet supplied with the riding documents.



created using
**BCL easyPDF
Printer Driver**

[Click here to purchase a license to remove this image](#)

Specifications and
technical descriptions

Care and
maintenance

Technical
Index

Minor repairs – things you can attend to yourself

You may not need it often, but it ought to be kept on hand:

– the tool kit!

The selection of tools permits all the jobs described in this section to be carried out without additional or special tools.

Tools and other items supplied with the motorcycle:

- 1 leatherette case
- 1 repair kit for tubeless tires
- 1 all-purpose pliers
- 1 large screwdriver (reversible blade)
- 1 small screwdriver
- 2 open-end wrenches, 10 x 13 mm and 17 x 19 mm
- 2 box wrenches, 10 x 12 mm and 17 x 19 mm
- 1 spark plug wrench
- 5 Allen wrenches: 3, 4, 5, 6 and 8 mm.

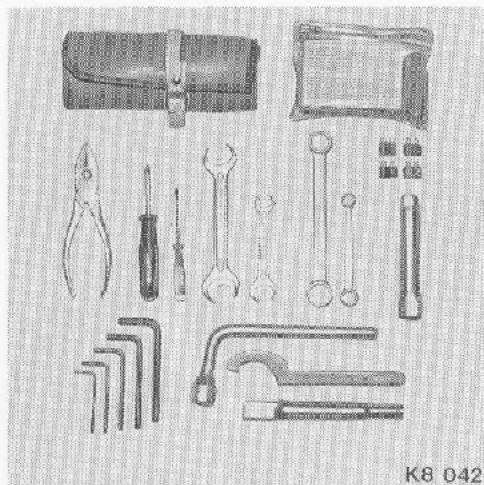

K8 042

- 1 box wrench for wheel bolts
- 1 hook wrench for spring strut
- 1 tubular extension
- 2 flat fuses, 7.5 and 15 A.

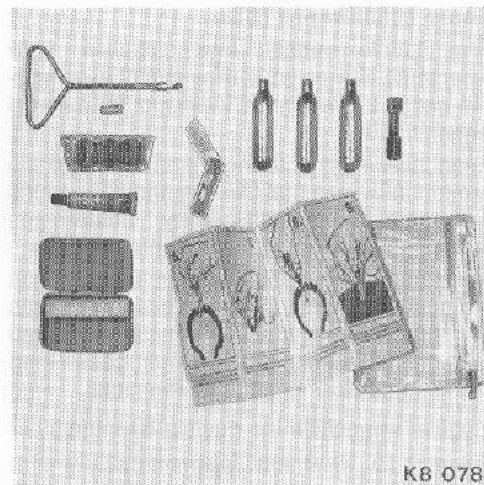

K8 078

BMW repair kit for tubeless motorcycle tires

This repair kit can be used to make a temporary repair if the tire has been punctured by a nail leaving a hole up to 4 mm (0.16 in.) in diameter.

Please refer to the instructions with the kit for repair procedure.

Warning:

After repairing a tire, your maximum speed should not exceed 37 miles per hour (60 km/h) and your maximum distance should be no more than 250 miles (400 km). Then the repaired tire must be replaced.



created using
**BCL easyPDF
Printer Driver**

[Click here to purchase a license to remove this image](#)

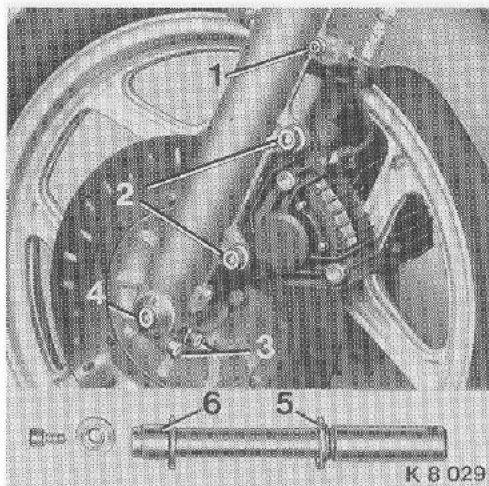

Removing and installing front wheel

Tools required:

- 5, 6 and 8 mm Allen wrench
- 10 mm box wrench
- Tubular extension.

Procedure:

- Unscrew brake pipe holder (1) and brake calipers (2) at left and right.
- Unscrew and remove axle bolt (4) and set it aside together with the shaped washer.
- Unscrew the axle clamp bolts (3) at left and right.
- Place the motorcycle on its center stand and get someone to sit or press down on the rear of the dualseat so that the front wheel is clear of the ground.
- Place a suitable support under the engine (arrow).

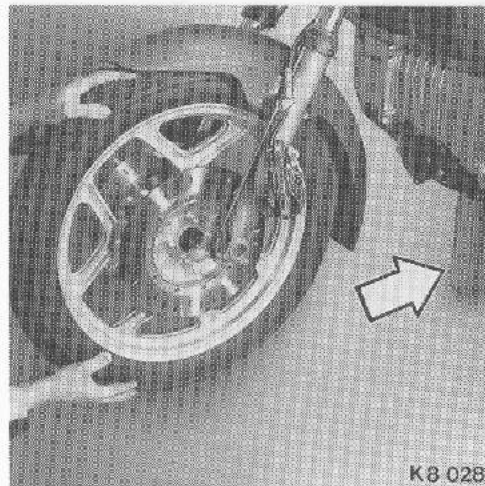

- Mark the installed position and direction of rotation of the front wheel, or note the direction arrow on the side of the tire. The brake caliper or disc must not be accidentally moved to the opposite side.
- Insert an Allen wrench in the cross-hole on the right, turn the axle slightly backward and forward and pull it out to the right.
- Allow the wheel to roll forward and catch spacing bushings (5) and (6).

Note:

Do not operate the handbrake lever with the front wheel removed. Prevent dirt and moisture from reaching the wheel bearings.

Extreme care must be exercised when handling wheel once removed. Brake disc(s) can be damaged from side loads. Remember this when changing tires.

When installing:

- Be sure to install tire/wheel in correct direction. Note sense of rotation. See mark on sidewall of the tire.
- Spacing bushings (5) and (6) must be on the correct sides; looking forward, these are:
 - left = wider bushing
 - right = narrower bushing.
- Grease the axle lightly.
- Place both brake calipers carefully over their discs.
- Before tightening the axle clamp bolts (3), lower the motorcycle from its stand and compress the telescopic forks firmly several times, without applying front brake to ensure that there are no trapped stresses in the fork legs.
- The tubular extension may be needed when tightening the axle bolt (4) and the brake caliper retaining bolts (2).
- At the earliest opportunity, have the bolt tightening torques checked by a qualified service technician.

Brake caliper retaining

bolts (2) = 32 ± 2 Nm
(23 ft.lbs.)

Axle clamp bolts (3) = 14 ± 2 Nm
(11 ft.lbs.)

Axle bolt (4) = 33 ± 4 Nm
(24 ft.lbs.)





K 8 032



K6 015

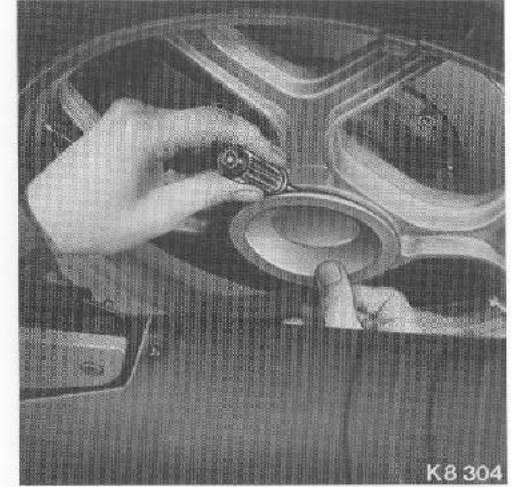

K8 304

Removing and installing rear wheel

Tools required:

- Large screwdriver (reversible)
- Wheel lug wrench
- Tubular extension.

Procedure:

- Take out the two Phillips-head screws on the license plate holder (arrows).

- Open the dual seat and remove the storage compartment cover.
- **Loosen but do not remove** the two nuts and covers (arrows).
- Pull off the license plate holder to the rear.

- Pry off the wheel hub cap with a screwdriver blade inserted at alternate sides in the cut-outs provided.



created using
BCL easyPDF
Printer Driver

[Click here to purchase a license to remove this image](#)

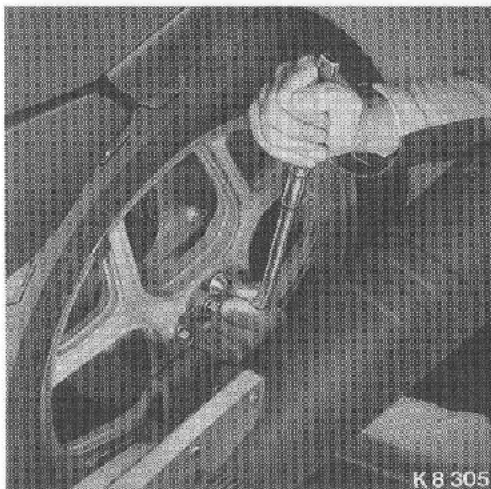

- Select first gear.
- Unscrew the four wheel bolts with the lug wrench and tubular extension, and remove them (complete with the taper washers).
- Pull the wheel off its centering stub and roll out to the rear.

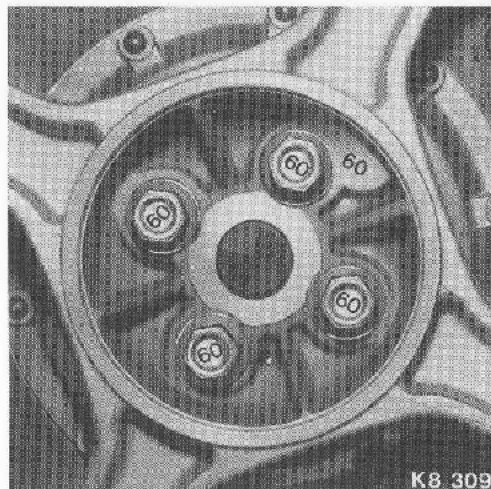

When installing:

- Note the steel washer between the wheel and the brake disc when the wheel is installed.
- The wheel centering spigot and the contact surfaces of the wheel hub, brake disc and steel washer must be absolutely clean and free from grease.
- Use wheel studs with size code No. "60" only. The stud heads and rear wheel are marked accordingly.
- Use the box wrench with the tubular extension to tighten the wheel studs.
- At the earliest opportunity, have the tightening torque (105 Nm [77 lb.ft.]) checked by a qualified service technician.



created using
BCL easyPDF
 Printer Driver

[Click here to purchase a license to remove this image](#)

Specifications and
 technical descriptions

Care and
 maintenance

Technical
 Index

Replacing bulbs and fuses

Before working on the electrical system, disconnect the negative battery lead at the gearbox.

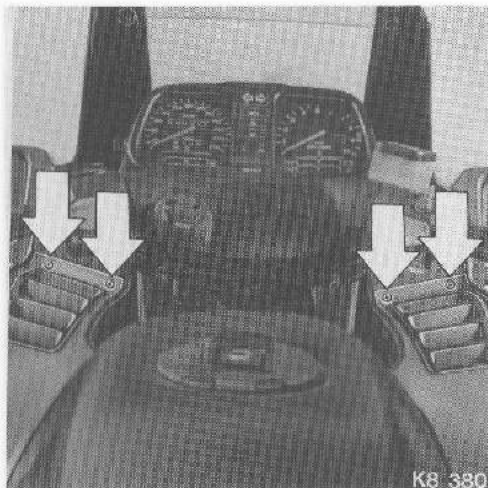

K 100 RS: Replacing parking light bulb and H 4 headlight bulb

Tools required:

- Screwdriver with reversible blade

Replacing parking light bulb

Procedure:

- Undo the upper retaining screws at the left and right knee pads.

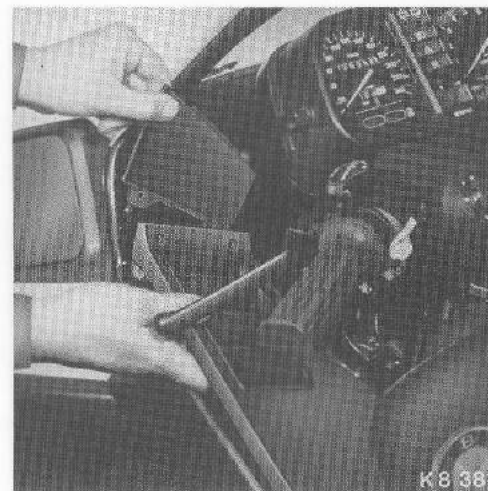

- Lift off the covers which have become accessible at left and right.



created using
**BCL easyPDF
Printer Driver**

[Click here](#) to purchase a license to remove this image

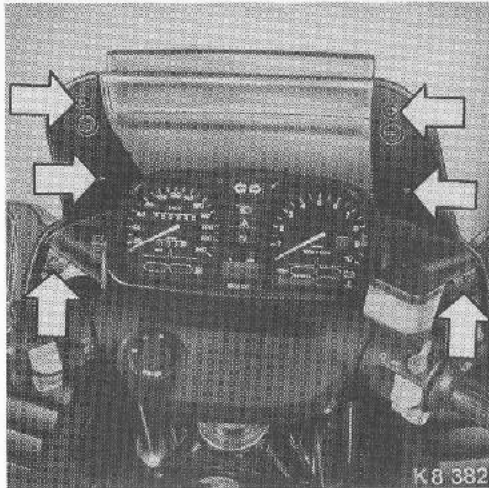

- Undo the retaining screws (arrows) for the windscreen trim and push the trim to the side.

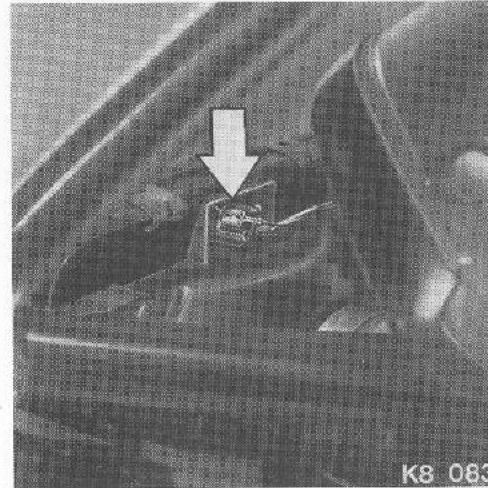

- Release the parking light bulb holder (arrow) by turning to the left.
- Push the bulb into the holder and turn to the left to remove.

When installing:

Do not touch the glass of new bulbs with the fingers; always use a clean cloth instead. (Dirt and grease will otherwise be burned into the glass and will reduce the light intensity.)

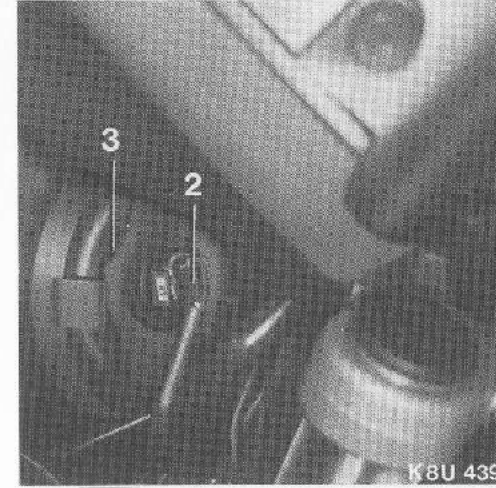

Replacing the H 4 bulb

- Pull out multi-pin plug (2).
- Pull off the protective rubber cap.
- Release the lock ring for the H 4 bulb by turning it to the left, and remove with the H 4 bulb from the reflector.



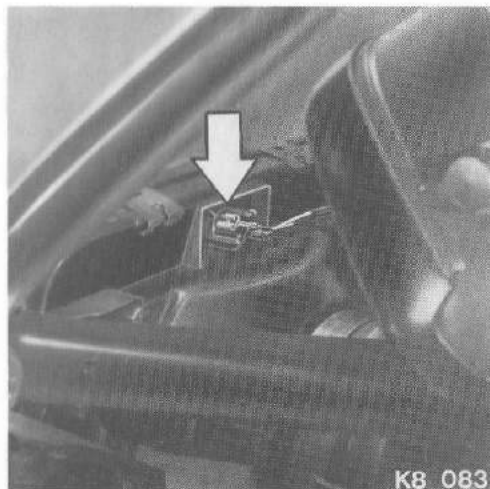

K 100 RT: Replacing parking light bulb and H 4 headlight bulb

No tools are needed.

Replacing parking light bulb

Procedure:

- Release the parking light bulb holder (arrow) by turning to the left.
- Push the bulb into the holder and turn to the left to remove.

When installing:

Do not touch the glass of new bulbs with the fingers; always use a clean cloth instead. (Dirt and grease will otherwise be burned into the glass and will reduce the light intensity.)

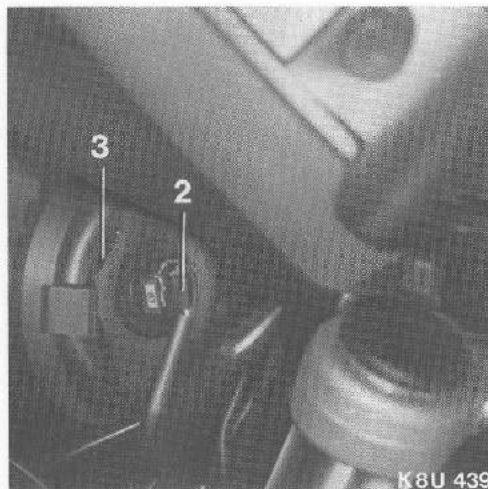

Replacing the H 4 bulb

- Pull out multi-pin plug (2).
- Pull off the protective rubber cap (3).
- Release the lock ring for the H 4 bulb by turning it to the left, and remove with the H 4 bulb from the reflector.



created using
**BCL easyPDF
Printer Driver**

[Click here to purchase a license to remove this image](#)

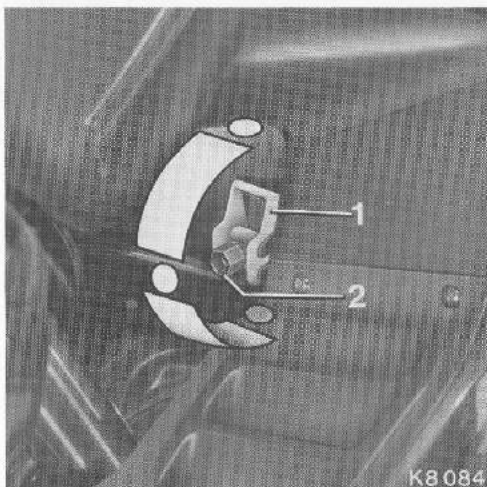

Top lever position
= long beam
Center lever position
= neutral beam
Bottom lever position
= short beam

- Turn the plastic hex screw (2) to achieve more exact adjustment between lever positions.

Adjust the headlight beam setting as shown in the diagram on page 45. **When carrying out the adjustment, the lever should be at the top position.** In this way, 2 additional beam positions are available quickly as the weight carried by the motor-cycle is increased.

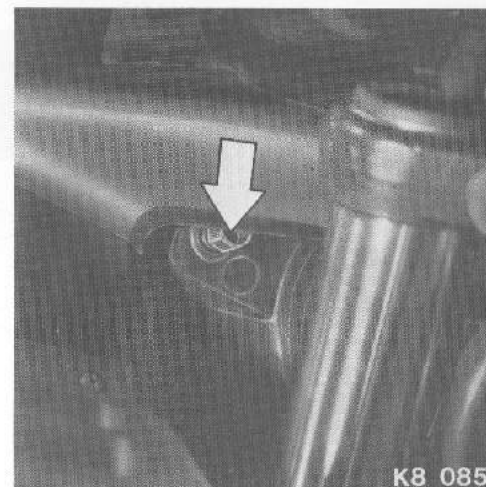

Lateral adjustment of the headlight beam is made by turning the plastic hex screw (arrow) near the left fixed telescopic fork tube:

- Turning to the right = beam more to the left
- Turning to the left = beam more to the right

Manual headlight beam adjustment – K 100 RS

The beam setting and sideways beam deviation can both be adjusted.

The headlight beam adjusting mechanism is located near the right fixed telescopic fork tube.

- A 3-position lever (1) is provided for fast headlight beam adjustment to the load condition of the motorcycle.

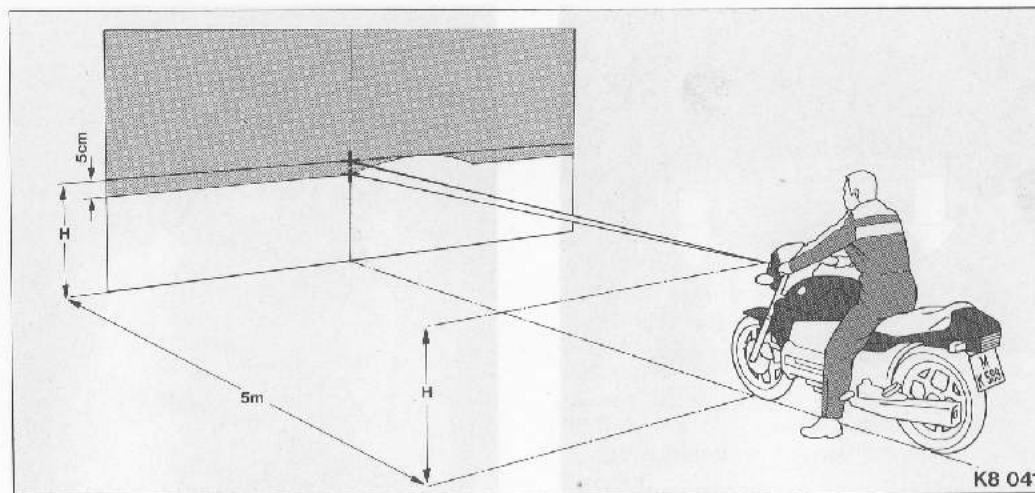

Aiming headlight beam

With the tire pressures correct and the spring strut set for one-up riding, place the motorcycle on its wheels 5 m/5.5 yards (16.4 ft.) from a light-colored wall with a rider seated on it. The floor should be flat; measure the distance from the wall to the center of the front wheel.

Transfer the distance from the ground to the headlight center to the wall and mark with a cross. Make a second cross 2 inches (5 cm) below the first.

Switch on the low headlight beam. Operate the adjusting mechanism until the light/dark boundary passes through the lower cross, rises to the height of the first cross on the right and then drops back again.



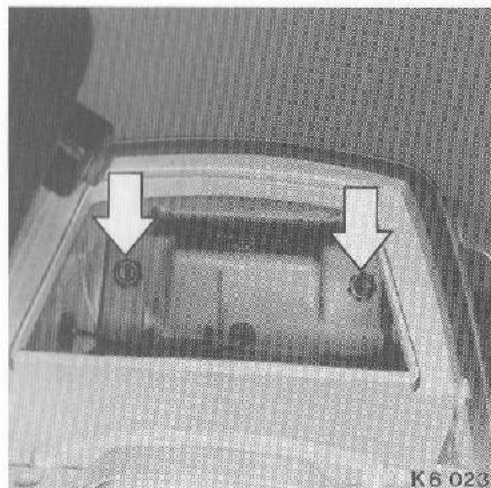

Replacing rear or brake light bulb

No tools are needed.

Procedure:

- Open the dual seat and take off the storage compartment cover.
- Take out the two knurled screws (1 and 2) by hand and at the same time take off the rear light insert.
- Press together the clip holding the rear or brake light bulb (in the direction shown by the arrow), and pull it out of the rear light insert.
- Press the bulb into its holder and turn it to the left to remove.

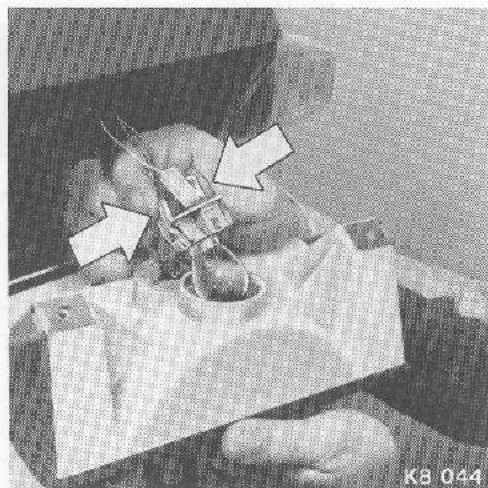

Replacing turn indicator bulb

Tool required:

- Screwdriver with reversible blade.

Procedure – K 100 RS:

- **Front** – Take out the Phillips-head screw and remove the lens.
- Push the bulb into the holder and turn it to the left to remove.
- **Rear** – Take out the Phillips-head screw and at the same time detach the turn indicator light assembly.
- To renew the bulb, see procedure for rear or brake light bulb.

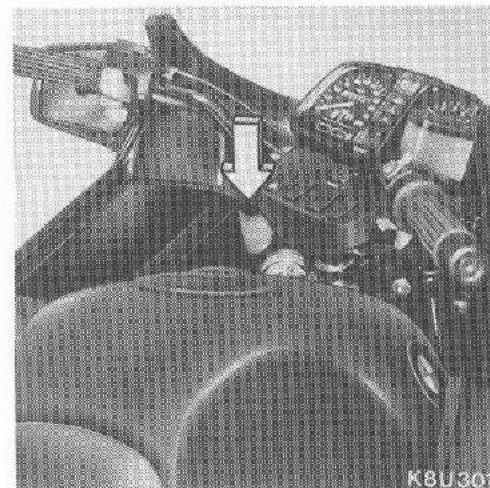

Procedure – K 100 RT:

- **Front** – Turn the front wheel fully to the left to gain access to the right-side bulb holder and to the right to gain access to the left-side bulb holder (see picture).
- Release the bulb holder by turning to the left.
- Push the bulb into the holder and turn it to the left to remove.
- **Rear** – Follow the instructions for the K 100 RS.

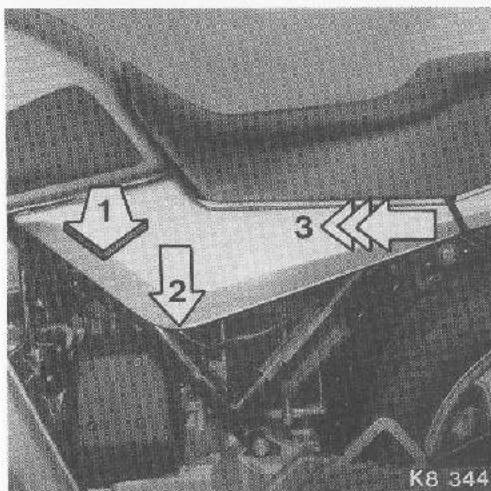

K8 344

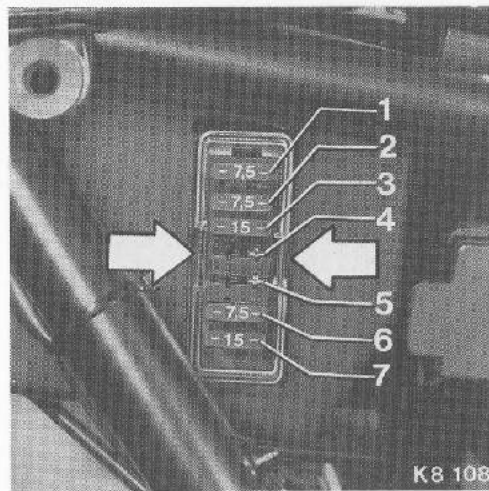

K8 108

Replacing fuses

The electrical fuses are located under the left battery cover.

Take off the battery cover as illustrated.

When installing:

It is easier to attach the battery cover if the three rubber retainers are moistened first.

Electrical circuits and their fuses:

- | | |
|-----------|---|
| 1 = 7.5 A | Instrument cluster
Rear/brake lights |
| 2 = 7.5 A | Parking light |
| 3 = 15 A | Turn indicators
Clock (optional extra on K 100) |
| 4 = 15 A | Power socket (optional extra) |
| 5 = 15 A | Optional extra equipment
(alarm, driving lights, etc.) |
| 6 = 7.5 A | Fuel pump |
| 7 = 15 A | Twin-tone horns
Fan |

Press the transparent cover lightly together (in direction of arrow) and take it off.

Pull the suspected blown fuse out of its holder. The melted metal strip can only be seen when the fuse has been taken out.

Always insert a new fuse of the same rating.

Warning:

Never use a fuse with a different rating from that specified. Serious damage to the electrical system or a fire may result, causing a dangerous loss of lights or engine power at night or in traffic. Always carry spare fuses with you.

If a fuse blows repeatedly, this indicates a fault in the electrical system. Contact your nearest BMW dealer or qualified service technician to trace and repair the problem.

Caution:

Always switch off the ignition when renewing a fuse.



created using
BCL easyPDF
Printer Driver

[Click here to purchase a license to remove this image](#)

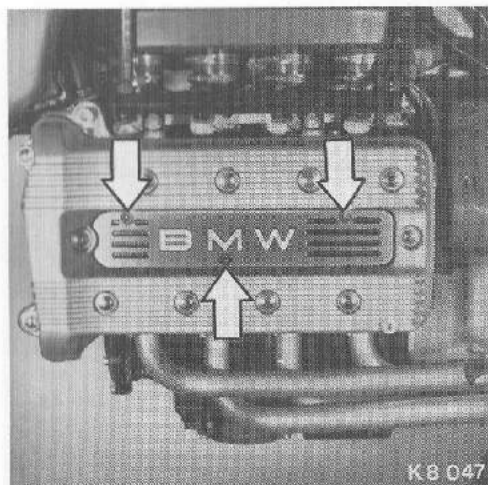

Replacing spark plugs

Tools required:

- 5 mm Allen wrench
- All-purpose pliers
- Spark plug wrench combined with
- Wheel lug wrench.

Procedure:

- Remove the cover from the spark plugs by taking out the three Allen screws (arrows).



- Carefully detach the spark plug leads with the pliers (reconnect in the same manner).
Rubber spark plug caps can be pulled off and re-attached by hand.

Warning:

Do not attempt to operate the engine with the spark plugs disconnected; severe shock to persons or damage to electrical equipment may result.

- Unscrew the spark plugs with the combined socket wrench from the tool kit (do not tilt the wrench).

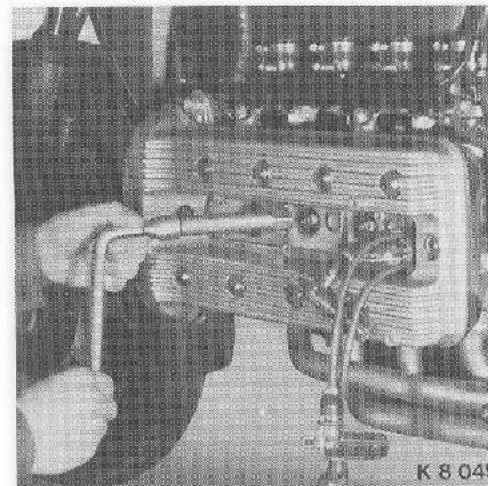

When installing:

- Always check that the electrode gap is $0.6 + 0.3$ mm ($0.024 + 0.012$ in.) before screwing in the plug. The spark plug gap must never be smaller than this. Replace the spark plugs if the electrode gap is 0.9 mm (0.036 in.) or above.
- Tighten the spark plugs carefully without using the tubular extension. Do not tilt the wrench (Tightening torque max. 20 ± 2 Nm [15 lb. ft.]).
- Use only factory-specified spark plugs – see Specifications, page 73.

Caution:

Do not adjust spark plug gap as the side electrode (ground) may be weakened and fail. Spark plugs not in accordance with specifications



created using
BCL easyPDF
Printer Driver

[Click here to purchase a license to remove this image](#)

Spark plugs

Checking spark-plug appearance

The spark plugs might be described as the "clinical thermometers" of the engine, and should be treated with special care.

The appearance of the spark plugs can provide important information regarding the performance of the ignition and fuel injection system, engine condition and operating characteristics.

Procedure:

- Ride the motorcycle for approx. 10 km (6 miles) at moderate engine speeds to warm up the engine.
- Pull in clutch lever and switch off the engine while the motorcycle is still moving.
- The engine should not run for an extended period at idle speed immediately before switching it off.
- Unscrew and remove the spark plugs.



Normal

Insulator nose colored light grey to fawn-brown.

The spark-plug heat range is correct.

Engine condition, combustion and combustion temperature are correct.

The ignition and fuel injection systems are functioning properly.

Sooty (right picture)

Spark plug covered with soft, dry soot deposits.

Effects:

- Poor cold-starting
- Ignition misfires (creep currents)
- Dark exhaust emissions

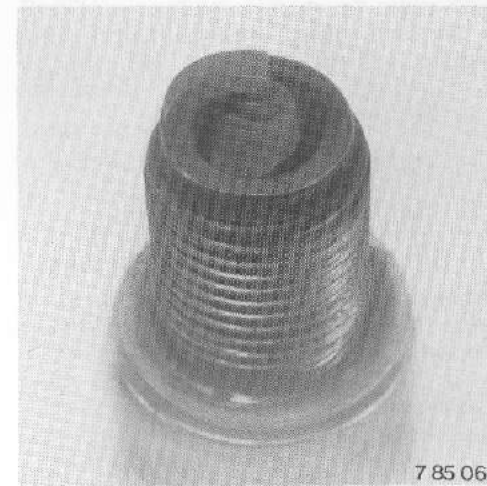

Possible causes:

- Fuel injection system faulty (mixture too rich)
- Blocked air cleaner
- Constant short journeys
- Spark plugs too "cold" (incorrect heat range)

Remedies:

- Have the fuel injection system examined by a BMW motorcycle service station
- Renew air cleaner
- Use spark plugs with correct heat range (see Page 73)



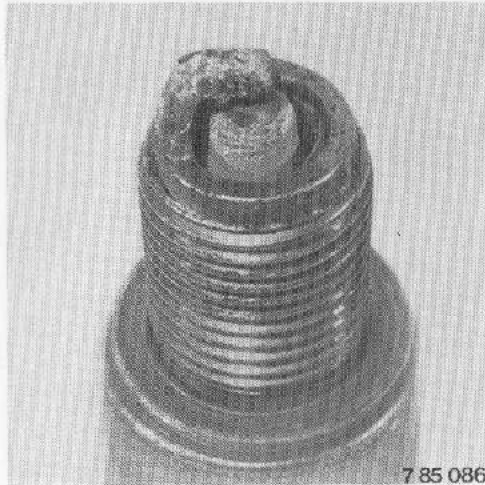

Bright (overheated)

Electrodes and spark-plug housing colored snow-white despite extended period of operation.

The center and ground electrodes show signs of melting due to excessively high temperatures and self-ignition.

Effects:

- Power loss
- ignition misfires
- Total engine failure (engine damage)

Possible causes:

- Fuel injection system faulty (mixture too lean)
- Ignition timing advanced too far

- Deposits in combustion chambers
- Spark plugs too "hot" (incorrect heat range)

Remedies:

- Have the ignition and fuel injection systems, combustion chambers and valves examined by your BMW dealer or a qualified service technician
- Use spark plugs with correct heat range (see Page 73)

Coated with oil (right picture)

Electrodes and spark-plug interior covered with black oily film.

Effects:

- Poor starting
- Ignition misfires

Possible causes:

- Oil in combustion chambers
- Worn pistons, cylinders or valve guides

Remedy:

- Have the engine repaired by your BMW dealer or a qualified service technician.

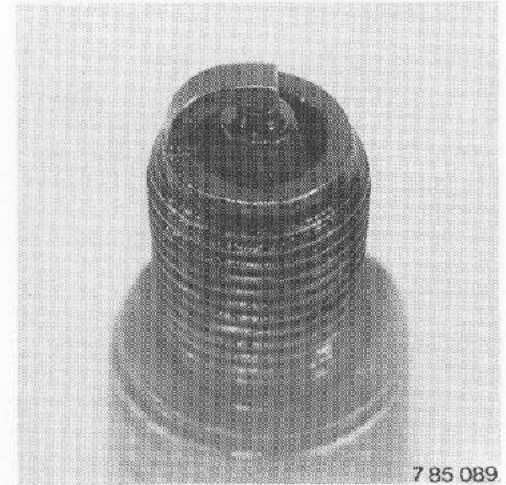

General: worn electrodes

Effects:

- Poor starting
- Ignition misfires, especially when accelerating

Possible causes:

- Spark plugs not renewed at proper interval (every 15 000 km/10 000 miles)

Remedy:

- Renew spark plugs



created using
**BCL easyPDF
Printer Driver**

[Click here to purchase a license to remove this image](#)

Cooling system – basic information

The equalizing tank for the coolant circuit is located under the right battery cover. It is always at zero pressure, whereas the remainder of the cooling system is pressurized at a value dependent on engine temperature.

A valve mechanism maintains the correct flow of coolant according to pressure. This means that when the engine is at its normal operating temperature the level in the coolant equalizing tank rises (thermal expansion), but is lower when the engine is cold.

Important: For this reason the coolant level must only be checked in the equalizing tank when the engine is cold, and topped off to the maximum mark if necessary.

If a large amount of coolant is lost or the coolant is replaced, take off the fuel tank and add coolant through the main filler pipe. The coolant should be completely charged at least every two years.

Use only manufacturer-approved longlife antifreeze with corrosion inhibitor.

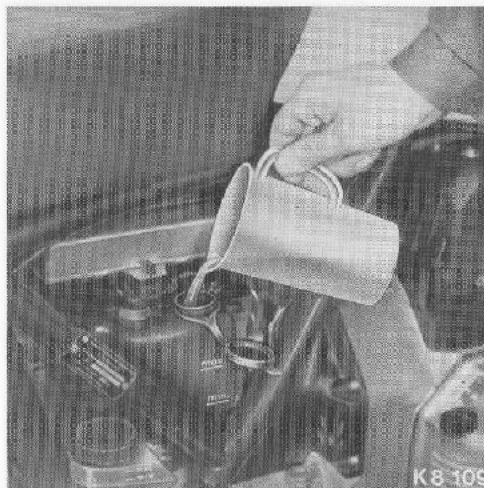

Correcting coolant level in equalizing tank (small coolant loss only)

No tools required.

Procedure:

- Carefully remove right battery cover – see Page 47.
- Pull off the filler cap and add coolant up to the maximum level mark (engine must be cold).

Refilling cooling system at main filler pipe (after a fairly large amount of coolant has been lost or the coolant renewed)

Tools required:

- Screwdriver with reversible blade
- 10 mm open-ended wrench.

Warning:

Gasoline is extremely flammable and is explosive under certain conditions. Refuel in a well ventilated area with the engine stopped. Do not smoke or allow flames or sparks in the area where the motorcycle is refueled or where gasoline is stored.



created using
**BCL easyPDF
Printer Driver**

[Click here to purchase a license to remove this image](#)



Procedure – K 100 RS:

- Undo the 3 retaining screw (arrows) and take off the left knee pad.

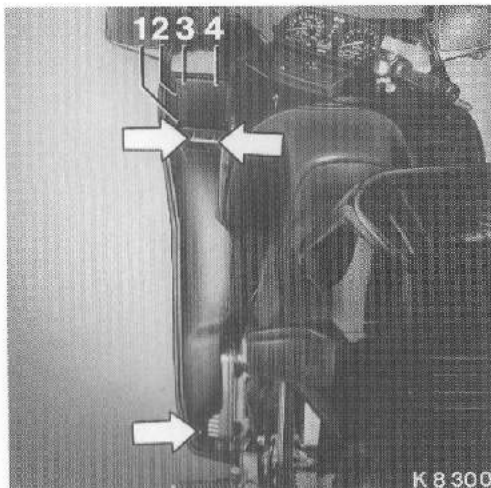

Procedure – K 100 RT:

- Release and remove the cover from the left-side storage compartment.
- Undo the 3 retaining screws (arrows) and remove the left knee pad to the rear from above.
- Undo retaining screws (1 through 4) and detach the storage compartment from above.
- Remove the holder for the storage compartment from the trim (2 Phillips-head screws).



Before taking off the fuel tank:

- Take off the left and right battery covers as shown on Page 47.
- Place a rag under the fuel collector pipe to soak up any leaking fuel.



created using
**BCL easyPDF
Printer Driver**

[Click here](#) to purchase a license to remove this image

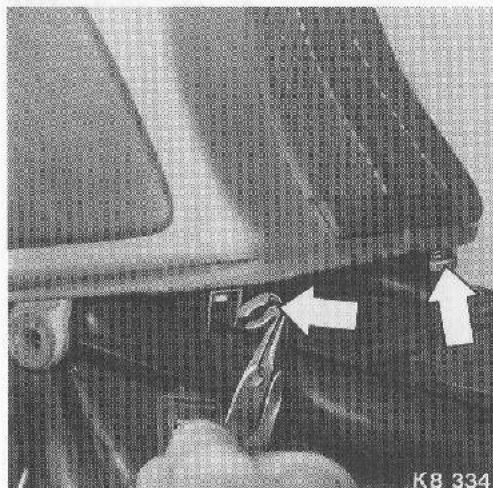

K8 334

- Pull the electrical plug connection for the fuel level sensor out of the retainer at the front right storage compartment and separate the plug connection.
- Pull the two retaining clips (arrows) off the keeper pins.
- Lift the rear of the fuel tank out of the two rubber bearings.
- Disconnect overflow and pressure relief lines from right side bottom of fuel tank. Do not confuse these lines. Ensure that neither line is pinched or kinked.
- Pull the fuel tank slightly back and carefully set it down on the left.

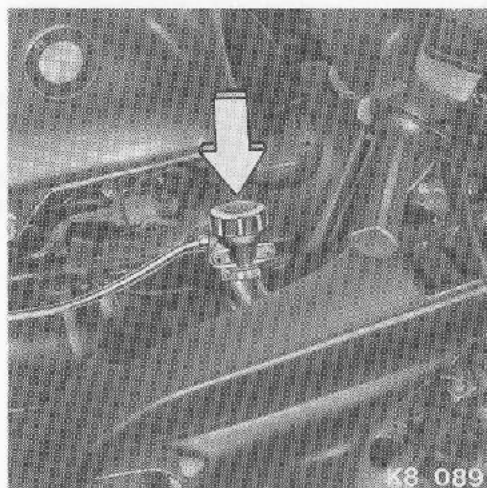

K8 089

- **Open the screw cap (arrow) on the main filler pipe only when the engine has cooled down** (when the engine is warm, the cooling system may be at a pressure of up to 1.1 bar/16.5 psi).

Caution:

To avoid risk of scalding, do not open cap with engine hot. Allow engine to cool, then open the screw cap carefully with a glove or cloth to protect the hand, and permit the excess pressure to escape.

- Add the missing quantity in the correct concentration.

Example:

Mixing ratio 40 : 60 antifreeze to water for protection down to a temperature of -28°C (-17°F).

Note also the antifreeze supplier's instructions.

- Attach the fuel tank temporarily, and run the engine briefly. Squeeze the coolant hoses by hand to bleed the cooling system.
- Take off the fuel tank and add coolant as necessary. Seal the system.
- After installing the fuel tank, run the engine until warm and then allow it to cool down again. If necessary, top up the coolant level in the equalizing tank as far as the maximum mark.



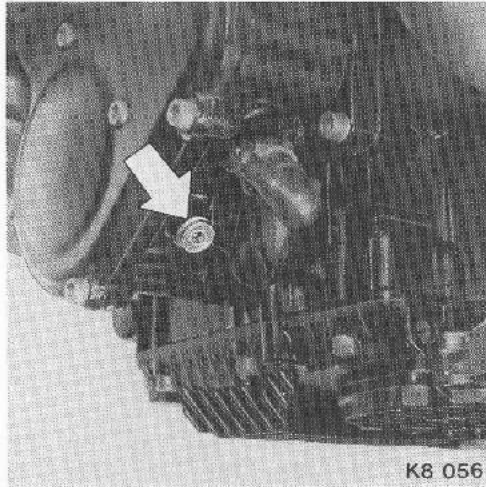

K8 056

Draining the coolant

Tool required:

- 5 mm Allen wrench.

Procedure:

- Take out the threaded union (arrow). Trap the escaping coolant in a suitable container. It can be re-used if not life-expired.
- Note the instructions for refilling and bleeding the cooling system.

Cooling system content 2.8 l (3 quarts) + 0.4 l (approximately 1/2 quart) in equalizing tank.

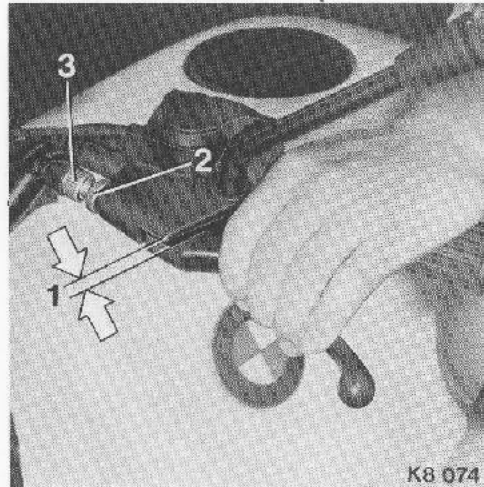

K8 074

Adjusting the clutch

If free travel at the clutch lever on the handlebar (1) varies from the specified value of 4 + 0.5 mm (16 + 0.02 in.), the basic adjustment procedure must be carried out.

Tools required:

- 13 mm open-ended wrench.
- 10 mm closed-end wrench.

Procedure:

- Measure the exposed length of cable (A) at the clutch lever on the gearbox. It should be 75 ± 1 mm (2.95 ± 0.04 in.).

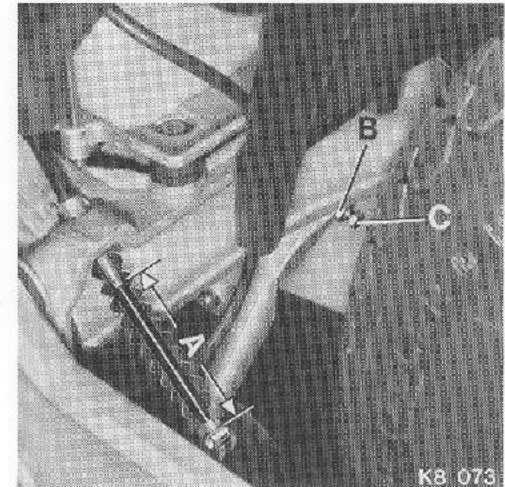

K8 073

- Correct to this length if necessary by slackening off locknut (2) and turning adjusting screw (3).
- Slacken off locknut (B) at the clutch lever on the gearbox. Turn adjusting screw (C) by hand up to its stop and secure it there with locknut (B).
- Adjust free travel (1) at the clutch lever on the handlebar to 4 + 0.5 (0.16 + 0.02 in.) with adjusting screw (3), and tighten locknut (2).

Warning:

Retracting mechanism of the automatic side stand must be adjusted at maximum travel at the clutch lever on the gearbox.



created using
**BCL easyPDF
Printer Driver**

[Click here to purchase a license to remove this image](#)

What to do if . . .

Malfunctions, possible causes and suggested remedial action

First of all, an important reminder:

Your motorcycle is equipped with a microprocessor-controlled high-performance digital ignition system. As a result, it can be highly dangerous or even fatal to touch any live components when the engine is running.

Malfunction	Possible cause	Remedial action
Engine will not start or is difficult to start	● Ignition key not in correct position	See operating instructions, Page 12
	● Ignition cut-out switch not turned on	See operating instructions, Page 21
	● Power supply interrupted	Fuse 1 blown, see Page 47
	● Gear engaged, clutch lever not pulled up	Select neutral at gear change pedal or disengage clutch
	● No fuel in tank	Add fuel, see Page 14
	● Fuel pump not working	Fuse 6 blown, see Page 47
	● Throttle twistgrip/cold-start control (choke) not operated correctly	See operating instructions, Page 21
	● Blocked air cleaner element	Renew, see Page 86, 87
	● Spark plug(s) defective/wet	Renew, see Page 48 – 50
	● Spark plug leads/caps wet	Dry with compressed airjet
● Battery flat	Recharge, see Page 90	
Coolant temperature too high, warning light remains on all the time (comes on above a temperature of 111° C [232° F])	● Coolant level too low	Trace and repair any leaks; add coolant, see Pages 51 – 54
	● Electric fan not switching on automatically (at approximately 103° C [217° F])	Blown fuse, see Page 47

Any more serious faults, and others not described on Pages 36 to 54 as being suitable for do-it-yourself repair, should be entrusted to your BMW dealer or a qualified service technician for attention.



Work you should not normally perform yourself – a word to the BMW owner with some mechanical knowledge

Many motorcycle enthusiasts possess a remarkable amount of mechanical skill and aptitude and frequently perform their own maintenance and repair work.

In this section, and under the heading "Care and Maintenance", we have tried to take this into account and have accordingly described a number of procedures in sufficient detail.

But even if you feel confident, do not attempt any of the tasks we have refrained from describing.

This is because the ultra-modern technologies incorporated into many design areas on your BMW call for special tools, diagnosis and testing systems.

Your BMW dealer can satisfy all these requirements and therefore guarantee the standard of servicing you have a right to expect from BMW – for your own personal safety and to ensure that your motorcycle remains reliable and in good mechanical condition at all times.

For similar reasons, we recommend that you install only Genuine BMW Parts and Accessories. These too are guaranteed by your BMW motorcycle dealer.

For further information on this subject, see Page 92.



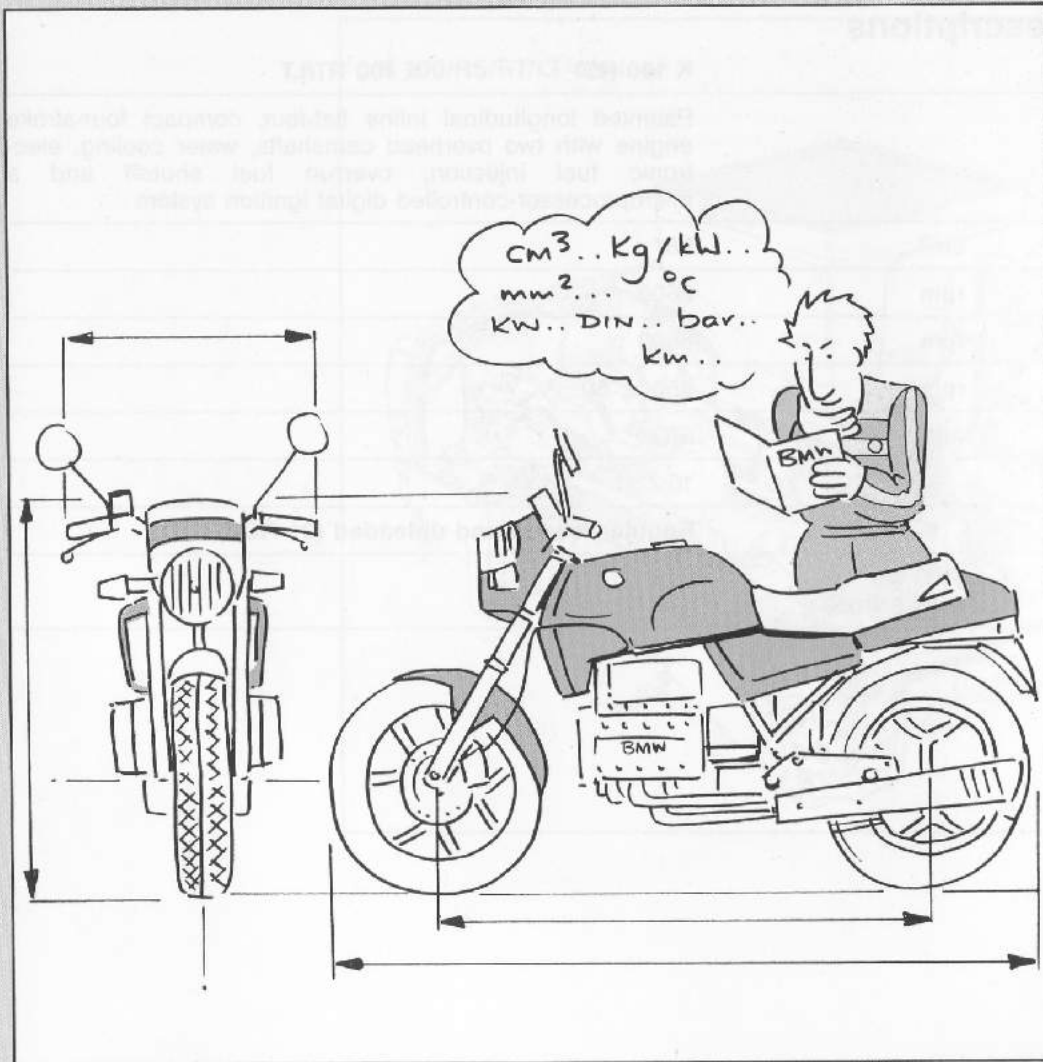

Data and information:

Specifications and technical descriptions

- Engine
- Cooling/lubricating systems
- Fuel injection
- Ignition system
- Transmission
- Frame
- Fuels, lubricants, etc.
- Electrical circuit diagram
- Electrical system
- Dimensions
- Weights

Specifications and technical descriptions

Care and maintenance



created using
**BCL easyPDF
Printer Driver**

[Click here to purchase a license to remove this image](#)

Specifications and technical descriptions

Engine		K 100 RS	K 100 RT/LT
Type		Patented longitudinal inline flat-four, compact four-stroke engine with two overhead camshafts, water cooling, electronic fuel injection, overrun fuel shutoff and a microprocessor-controlled digital ignition system	
Displacement, effective	cm ³	987	
Max. permissible engine speed	rpm	8600	
Max. continuous engine speed	rpm	8500	
Idle speed	rpm	950 ± 50	
Bore/stroke	mm	67/70	
Compression ratio		10.2 : 1	
Type of fuel		Regular leaded and unleaded (91 ROZ)	
Max. oil consumption	l/100 km Ounces/mile	0.15 0.08	



K 100/RS/RT/LT engine

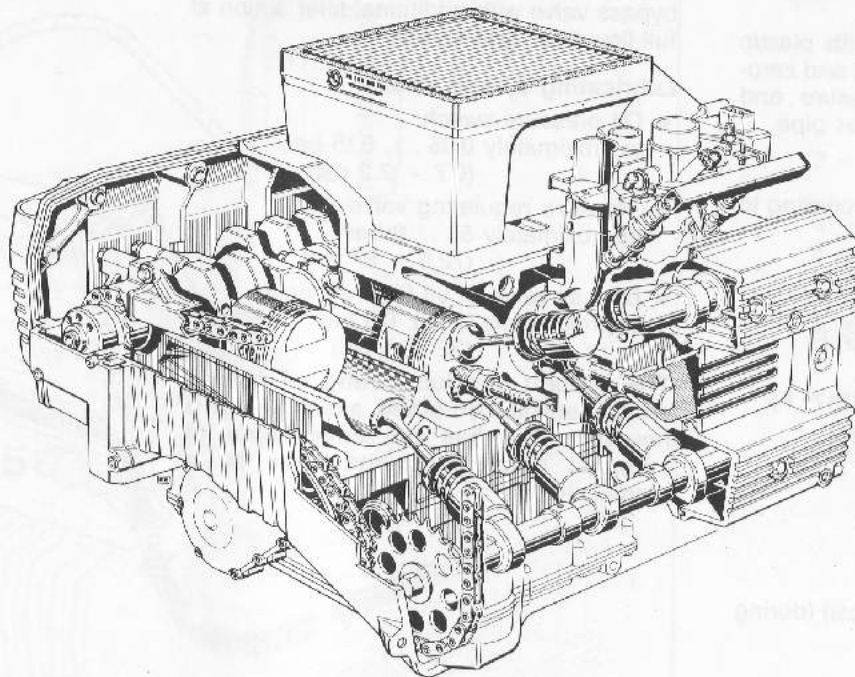

Cooling system

Liquid cooling circuit with centrifugal impeller pump.

Radiator

Crossflow aluminium radiator with plastic header tanks, integral thermostat and zero-pressure equalizing tank. Pressure and vacuum relief valves at main filler pipe.

Electric fan

Cuts in and out automatically according to coolant temperature.

Cooling system data

- Thermostat:
starts to open at 85° C (185° F)
- Fan:
cut-in temperature 103° C (217° F)
- Coolant overheat warning light:
comes on at 111° C (232° F)
- Pressure relief valve:
opens at 1.1 bar $\hat{=}$ 120° C
(16 psi $\hat{=}$ 248° F)
- Vacuum relief valve:
opens at -0.1 bar (-1.45 psi) (during cooling phase)

Lubricating system

Pressurized oil circuit driven by gear-type pump, with full-flow oil filter, pressure regulating valve on pump side and safety bypass valve with additional filter action at full-flow filter (wet sump).

Lubricating system data

- Oil pressure switch:
approximately 0.05 ... 0.15 bar
(0.7 - 2.2 psi)
- Pressure regulating valve:
approximately 5 ... 6 bar
(72.5 - 87 psi)
- Bypass valve in oil filter element:
approximately 2.2 \pm 0.3 bar
(32 \pm 4 psi)

The coolant and lubricating oil pumps are a central combined assembly in a housing; this has the advantages of compact dimensions and drive by a single shaft.

K 100 RS/RT/LT Operating diagram – cooling system

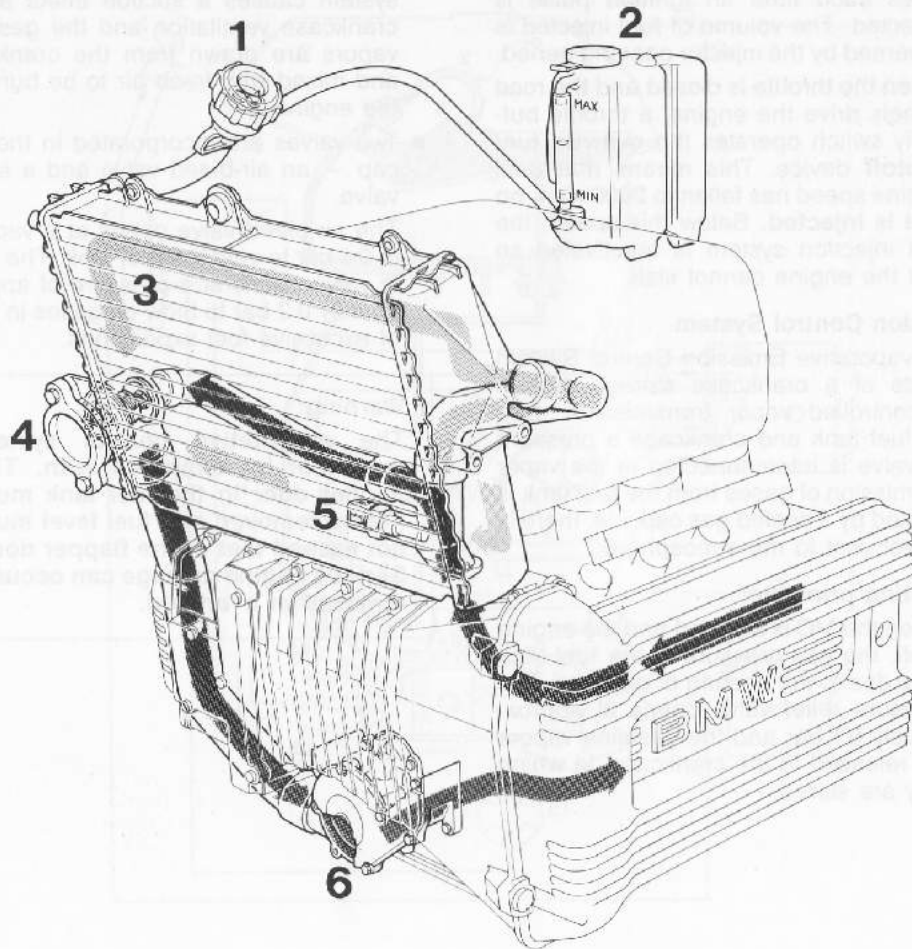

← = Flow of coolant with engine cold via bypass (thermostat closed)

← = Flow of coolant with engine at normal operating temperature via crossflow radiator (thermostat open)

1 = Main filler pipe with pressure and vacuum relief valve

2 = Equalizing tank with coolant level check and filler opening

3 = Crossflow aluminium radiator

4 = Thermostat with housing

5 = Temperature sensor

6 = Combined coolant and engine oil pump



created using
**BCL easyPDF
Printer Driver**

[Click here to purchase a license to remove this image](#)

Fuel injection system

The L-Jetronic electronically controlled fuel injection system with overrun fuel shutoff guarantees optimum performance with minimum fuel consumption, together with excellent warming up and very low exhaust emissions.

Operating principle:

- An electric roller-cell pump in the fuel tank, protected by filters, maintains a system pressure of approximately 2.5 bar (36 psi) in the ring line which supplies the injectors.
- The electronic control unit is supplied with the following signals from sensors:
 - intake air volume and temperature (at airflow meter),
 - engine speed
 - throttle butterfly opening
 - coolant temperature

and processes them to obtain output signals which control the injector opening period.

- Fuel is injected simultaneously at each turn of the crankshaft into all four intake pipes each time an ignition pulse is detected. The volume of fuel injected is governed by the injector opening period.
- When the throttle is closed and the road wheels drive the engine, a throttle butterfly switch operates the **overrun fuel shutoff** device. This means that until engine speed has fallen to 2000 rpm, **no fuel is injected**. Below this speed, the fuel injection system is reactivated so that the engine cannot stall.

Emission Control System

The Evaporative Emission Control System consists of a crankcase storage system with controlled vapor transmission. Between fuel tank and crankcase a pressure relief valve is interconnected in the vapor line. Emission of gases from the fuel tank is prevented by a sealed gas cap, i. e. there is no direct vent to the atmosphere.

Operating principle:

- When the MC is stopped and the engine is off, the gas pressure in the fuel tank rises due to the heating of gasoline. The pressure relief valve opens at approximately 0.1 bar and the gasoline vapors are released to the crankcase, in which they are stored.

- After the engine is started, the vacuum in the air collector of the air intake system causes a suction effect at the crankcase ventilation and the gasoline vapors are drawn from the crankcase and mixed with fresh air to be burnt by the engine.
- Two valves are incorporated in the gas cap – an air-bleed valve and a safety valve.

The air-bleed valve opens at a vacuum of 0.1 bar to vent the fuel tank. The safety valve opens at a pressure of approximately 0.2 bar to blow off gases in case of excessive fuel expansions.

Warning:

The evaporative control system must not be tampered with. The flapper door in the fuel tank must not be removed and fuel level must not exceed that of the flapper door. Serious engine damage can occur if removed or overfilled.



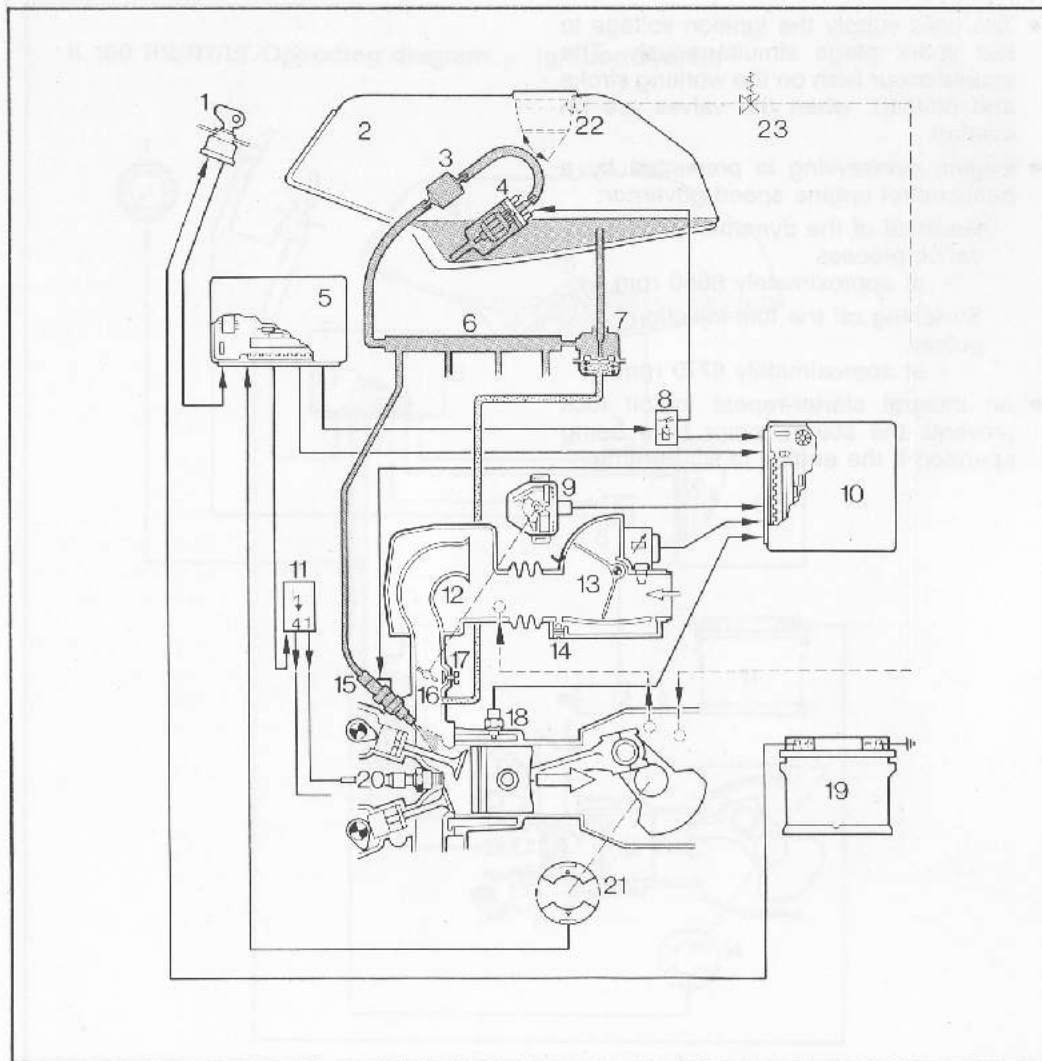

K 100 RS/RT/LT Operating diagram – L-Jetronic fuel injection

- 1 = Ignition switch
- 2 = Fuel tank
- 3 = Fuel filter
- 4 = Fuel pump
- 5 = Ignition control unit
- 6 = Distributor pipe
- 7 = Pressure regulator
- 8 = Injection relay
- 9 = Throttle butterfly switch
- 10 = Injection control unit
- 11 = Ignition coil
- 12 = Air collector
- 13 = Air volume gauge
- 14 = Idle mixture adjusting screw
- 15 = Injection valve
- 16 = Throttle valve
- 17 = Bypass pipe lift for idling
- 18 = Coolant temperature sensor
- 19 = Battery
- 20 = Spark plug
- 21 = Hall-effect transmitter
- 22 = Gas cap
- 23 = Pressure relief valve



created using
**BCL easyPDF
Printer Driver**

[Click here to purchase a license to remove this image](#)

Care and
maintenance

atica
Item Index

Ignition system

The all-electronic microprocessor-controlled digital ignition system has no contact-breaker points and therefore requires no routine maintenance.

Its central element is the digital control unit.

Operating principle:

- The ignition signal is triggered by two Hall-effect magnetic gate transmitters on the front end of the crankshaft.
- The control unit converts these pulses into a program with the following functions:
 - Building up the ignition spark
 - Activating the ignition advance and retard system in accordance with a programmed characteristic curve, depending on running speed.
 - Triggering the control pulses for the solenoid valves on the injectors.

- Two coils supply the ignition voltage to two spark plugs simultaneously. The sparks occur both on the working stroke and off-load, when the valves are on overlap.
- Engine overrevving is prevented by a dual-control engine speed governor:
 - Reversal of the dynamic ignition advance process
 - at approximately 8650 rpm
 - Switching off the fuel injection pulses
 - at approximately 8770 rpm
- An integral starter-repeat inhibit lock prevents the starter motor from being operated if the engine is still turning.



K 100 RS/RT/LT Operating diagram – ignition system

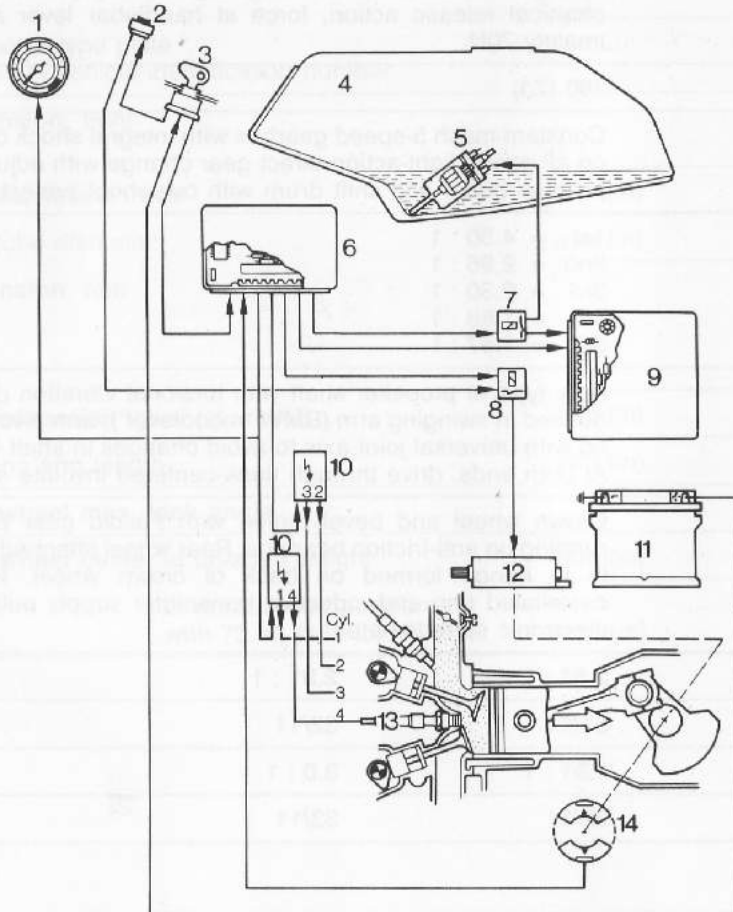

- 1 = Revolution counter
- 2 = Starter push button
- 3 = Ignition switch
- 4 = Fuel tank
- 5 = Fuel pump
- 6 = Ignition control unit
- 7 = Injection relay
- 8 = Starter relay
- 9 = Injection control unit
- 10 = Ignition coils
- 11 = Battery
- 12 = Starter
- 13 = Spark plug
- 14 = Hall-effect transmitter



created using
**BCL easyPDF
 Printer Driver**

[Click here to purchase a license to remove this image](#)

Care and
 maintenance

etical
 Item Index

Transmission		K 100 RS	K 100 RT/LT
Clutch		Single dry plate, mounted on output shaft and revolving in opposite direction to crankshaft, with lever-action diaphragm spring and asbestos-free lining. Light, easily-controlled mechanical release action, force at handlebar lever approximately 70N.	
Clutch plate diameter	mm (in)	180 (7.1)	
Gearbox		Constant-mesh 5-speed gearbox with integral shock damper on all gears; light-action direct gear change with adjustable-position pedal and shift drum with overshoot protection	
Gear ratios		1st = 4.50 : 1 2nd = 2.96 : 1 3rd = 2.30 : 1 4th = 1.88 : 1 5th = 1.67 : 1	
Transmission from gearbox to rear wheel		New type of propeller shaft with torsional vibration damper housed in swinging arm (BMW 'monolever'); arm pivot aligned with universal joint axis to avoid changes in shaft length. At both ends, drive through flank-centered involute splines	
Rear-wheel drive		Crown wheel and bevel pinion with Palloid gear pattern, running on anti-friction bearings. Rear wheel attached directly to flange formed on back of crown wheel. Integral castellated ring and inductive transmitter supply pulses for electronic speedometer	
Final drive ratio (standard version)		2.81 : 1	2.91 : 1
Number of teeth		31/11	32/11
Final drive ratio (special version)		2.91 : 1	3.0 : 1
Number of teeth		32/11	33/11



Frame and suspension		K 100 RS	K 100 RT/LT
Frame		Single-piece torsionally rigid lattice tube frame including engine and gearbox assembly as a stressed element; sidecar and trailer attachment not permitted	
Location of type plate		on rear right frame tube strut	
Location of vehicle identification number			
Suspension, front		Long-stroke, responsive telescopic fork with double-acting hydraulic dampers and progressive spring rates	
Total suspension travel	mm (in)	185 (7.3)	
Fixed tube diameter	mm (in)	41.4 (1.63)	
Suspension, rear		Swinging arm (BMW 'monolever') made from a high-strength light alloy, with a single suspension strut (progressive-rate coil spring and double-acting gas-filled telescopic damper); three-position setting to suit varying loads	
Total suspension travel (at wheel)	mm (in)	110 (4.33)	
Swinging arm length	mm (in)	400 (15.7)	
Front wheel max. lock angle		2 x 35°	2 x 35°
Front wheel caster at unladen weight	mm (in)	101 (3.98)	
in normal-load position with 75 kg (165 lb) rider	mm (in)	105 (4.13)	



Frame and suspension**K 100 RS****K 100 RT/LT****Front brake**

Hydraulic, twin disc, with slotted stainless-steel brake discs and two fixed calipers with semi-metallic brake pads

Brake disc diameter	mm (in)	285 (11.2)
Brake disc thickness	mm (in)	4 (0.16)
Piston diameter	mm (in)	38 (1.5)
Actuating cylinder diameter	mm (in)	13 (0.51)
Brake lining area	cm ² (in ²)	166 (25.7)

Rear brake

Hydraulic, fixed caliper disc brake integrated into rear-wheel drive. Stainless-steel disc, semi-metallic pads and brake application element for sensitive response

Brake disc diameter	mm (in)	285 (11.2)
Brake disc thickness	mm (in)	4 (0.16)
Piston diameter	mm (in)	38 (1.5)
Brake actuation		with input-side regulating element
Actuating cylinder diameter	mm (in)	13 (0.51)
Brake lining area	cm ² (in ²)	83 (12.9)

Frame and suspension	K 100 RS	K 100 RT/LT
Wheel and tires	BMW cast light alloy wheels of Y-spoke design and H-profile pattern	
Front wheel		
with inclined-shoulder rim and double hump		
Size and designation	2.50 – 18 MT H 2	
Tire size and designation ¹⁾	100/90 V 18 100/90 VR 18*	100/90 V 18 100/90 VR 18*
	– TUBELESS –	
Rear wheel		
with inclined-shoulder rim and double hump		
Size and designation	2.75 – 17 MT H 2	
Tire size and designation ¹⁾	130/90 V 17 140/80 VR 17*	130/90 V 17 140/80 VR 17*
	– TUBELESS –	

Tire pressuresin bar (lb/in²) with tires cold

Road speed	V-tires				VR-tires			
	One-up		Two-up		One-up		Two-up	
	Front	Rear	Front	Rear	Front	Rear	Front	Rear
Unrestricted	2,25 (32,6)	2,5 (36,3)	–	–	2,55 (37,0)	2,8 (40,6)	–	–
Up to 180 km/h (112 mile/h)	–	–	2,25 (32,6)	2,7 (39,2)	–	–	2,55 (37,0)	3,0 (43,5)
Above 180 km/h (112 mile/h)	–	–	2,7 (39,2)	2,9 (42,0)	–	–	3,00 (43,5)	3,2 (46,4)

Tire tread depths:

Front wheel = 2 mm (0.08 in)

Rear wheel = 2 mm (0.08 in) up to 130 km/h (81 mile/h)
= 3 mm (0.12 in) above 130 km/h (81 mile/h)**Warning:****Note the legal requirements concerning minimum tread depth.**

* Use them only in pairs

¹⁾ See your BMW dealer or refer to the tire information located under the dualseat for factory-approved brands, models and sizes.created using
**BCL easyPDF
Printer Driver**[Click here to purchase a license to remove this image](#)

Lubricants, etc.

K 100 RS

K 100 RT/LT

Engine oil

Brand-name HD oil for 4-stroke engines; API classifications SE and SF

Viscosity in relation to outside temperature

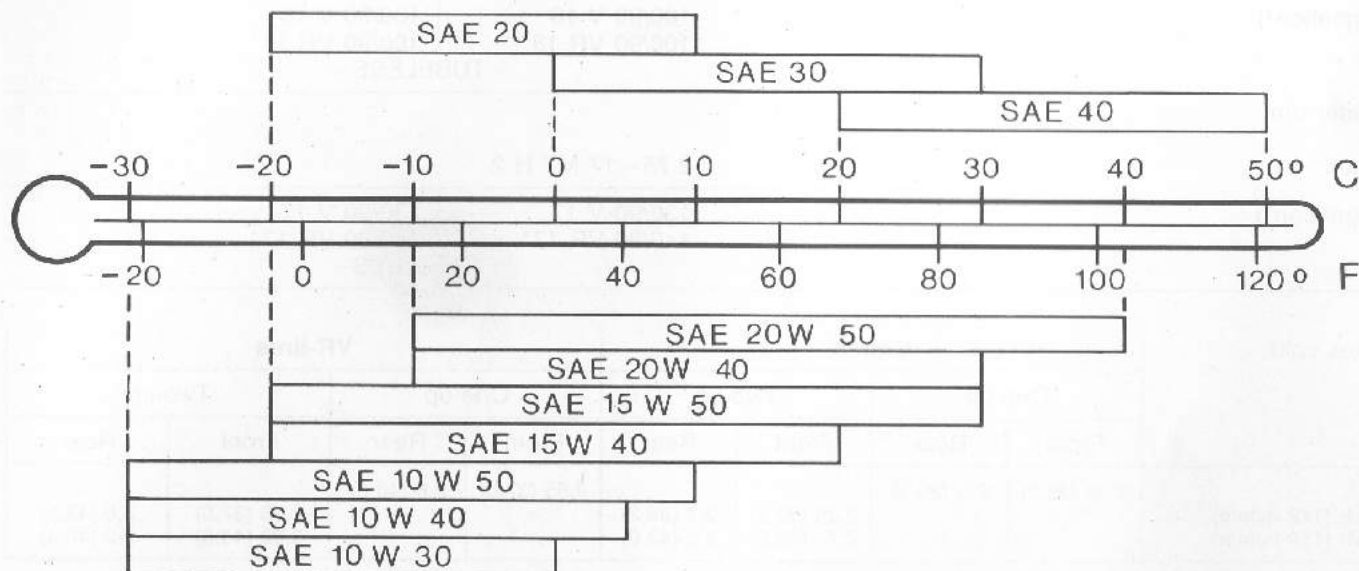

Engine oil content

without filter renewal

l (quarts)

3.50 (3.7)

with filter renewal

l (quarts)

3.75 (4.0)

Engine coolant

Brand-name long-life antifreeze and corrosion inhibitor

Content of cooling system

l (quarts)

2.8 (2.9) + 0.4 (0.4) in equalizing tank



created using
**BCL easyPDF
 Printer Driver**

[Click here to purchase a license to remove this image](#)

Lubricants, etc.		K 100 RS	K 100 RT/LT
Gear oil		Brand-name hypoid gear oil, API classification GL 5	
Gearbox content	l (quarts)	0.85 ± 0.05 (0.9 ± 0.05)	
Rear-wheel drive content	l (quarts)	0.26 (0.3)	
Viscosity above 5° C below 5° C alternatively	SAE	90	
	SAE	80	
	SAE	80 W 90	
Telescopic fork oil – approved grades		Bel-Ray-Fork Oil with “Seal Swell” SAE 5; Castrol Fork Oil Extra Light; Castrol DB Hydraulic Fluid; Castrol Shock Absorber Oil 1/-318; Castrol LMH (preferred at below 0° C); Golden Spectro Suspension Fluid Very Light; Mobil Aero HFA; Mobil DTE 11; Shell Aero Fluid 4; Shell 4001; High-performance – Telescopic Fork Oil (manufacturer: Wacker Chemie)	
Content per fork leg	l (ounces)	0.36 – 0.01 (12 – 0.3)	0.36 – 0.01 (12 – 0.3)
Greasing steering, wheel bearings and other lubrication points		Brand-name anti-friction grease, usable temperature range – 30° . . . +140° C (– 22° to 284° F), drip point 150° . . . 230° C (302° to 446° F), high corrosion protection, good water/oxidation resistance; e. g. Shell Retinax A	
Battery terminal posts – (anti-oxidant)		Acid-free grease, e. g. Vaseline	
Brake fluid		DOT 4: ATE “SL”	
Total content, front and rear circuits	l (ounces)	0.13 (4.4)	
For renewal, incl. flushing out, approx.	l (ounces)	0.30 (10.0)	



Key to electrical circuit diagram – K 100 RS/RT/LT

- | | | |
|---|---|--|
| 1 Instruments | d) Starter switch | 49 Valve 1 |
| a) Speedometer | e) Turn indicator cancel switch | 50 Valve 2 |
| b) Revolution counter | 15 Left handlebar switch assembly | 51 Valve 3 |
| c) 4 x instrument lighting | a) Horn switch | 52 Valve 4 |
| d) Battery charge telltale | b) High beam headlight switch | 53 Fuel pump |
| e) Not in use | c) Left turn indicator switch | 54 Starter motor |
| f) Gear indicator | 23 Left front turn indicator | 55 Not in use |
| g) Neutral indicating light (green) | 24 Right front turn indicator | 56 Not in use |
| h) Oil pressure telltale (red) | 25 Left rear turn indicator | 57 Not in use |
| i) Clock | 26 Right rear turn indicator | 58 Not in use |
| k) Turn indicator repeater,
left and right (green) | 27 Hazard warning flasher switch
(special equipment) | 59 Not in use |
| l) High beam telltale (blue) | 28 Rear light | 60 Horn relay |
| m) Cold-start (choke) telltale
(orange) | 29 Hall-effect transmitter II | 61 Headlight |
| n) Coolant overheat telltale (red) | 30 Ignition control unit | 62 Not in use |
| o) Low fuel level warning (red) | 31 Hall-effect transmitter I | 63 Spark plugs 1 . . . 4 |
| p) Bulb monitoring light (red) | 32 Coil 1 | 64 Not in use |
| 2 Inductive sensor | 33 Coil 2 | 65 Increase cold-starting speed (choke)
switch |
| 3 Gearbox switch | 34 Bulb monitor | 66 Connection for heated handlebar
grips (optional extra) |
| 4 Alternator | 35 Front brake light switch | 67 Connection for special equipment |
| 5 Battery | 36 Rear brake light switch | 68 Connection for burglar alarm
(optional extra) |
| 6 Temperature sensor | 37 Brake light | 69 Electrical equipment box |
| 7 Oil pressure switch | 38 Parking light | 70 Connection for additional instruments |
| 8 Temperature-sensing switch unit | 39 Not in use | 71 Connection for fairing cable RS/RT |
| 9 Fan motor | 40 Fuel injection relay | 72 Connection for altitude adjustment |
| 10 Flasher unit | 41 Fuse box | |
| 11 Fuel level sensor | 42 Ignition switch | |
| 12 Left horn | 43 Starter relay | |
| 13 Right horn | 44 Load-shedding relay | |
| 14 Right handlebar switch assembly | 45 Clutch switch | |
| a) Light switch | 46 L-Jetronic control unit | |
| b) Right turn indicator switch | 47 Airflow meter | |
| c) Emergency cutout switch | 48 Throttle butterfly switch | |

Electrical system		K 100 RS	K 100 RT/LT
Battery		BMW-Mareg, with transparent polypropylene casing	
Voltage/capacity	V/Ah	12/25 (standard version)	
Alternator		Three-phase alternator with all-electronic voltage regulator; direct drive, ratio 1 : 1.5	
Rating	W	460	
Starter motor		Permanent-magnet version with 4 reduction gears (ratio 27 : 1) and free wheel	
Rating	KW	0.7	
Ignition timing, statical	° CS	6 (advance)	
Firing order	Cyls.	1-3-4-2	
Spark plugs		M12 x 1.25 mm thread	
Approved make and type		Bosch X5DC Champion A 85 YC	
Electrode gap	mm (in)	0.6 + 0.1 (0.024 + 0.004)	
Electrode gap wear limit	mm (in)	0.9 (0.036)	



Electrical system		K 100 RS	K 100 RT/LT
Circuit protection		'Minifuse' flat-pattern fuses (7 circuits)	
Load rating	A	7.5 (3 circuits)	
	A	15 (4 circuits)	
Headlight – circular version, diameter	mm (in)	180 (7.09)	
	– square version	mm (in)	200 x 130 (7.87 x 5.12)
Bulbs High/low headlight beam		H4-halogen, 60/55 W, asymmetric dipped beam	
Parking light		12 V/ 4 W	Standard designation T 8/4
Rear light cluster: rear light brake light		12 V/10 W	Standard designation R 19/10
		12 V/21 W	Standard designation P 25-1
Flashing turn indicators		12 V/21 W (4 x)	Standard designation P 25-1
Instrument cluster: turn indicator repeater		12 V/ 4 W (2 x)	Standard designation T 8/4
Other telltale and warning lights, instrument lighting		12 V/ 3 W (3 x)	Standard designation W 10/3

Dimensions		K 100 RS	K 100 RT/LT
Overall length	mm (in)	2220 (87.4)	
Width over mirrors	mm (in)	800 (31.5)	920 (36.2)
Width over handlebar	mm (in)	610 (24.0)	770 (30.3)
Width over rider's footrests	mm (in)	640 (25.2)	
Width over passenger footrests	mm (in)	690 (27.2)	
Max. height (excluding mirrors)	mm (in)	1271 (50.0)	1460 (57.5)
Seat height at unladen weight	mm (in)	810 (31.9)	
Wheelbase at unladen weight	mm (in)	1516 (59.7)	
in normal-load position with 75 kg (165 lb) rider	mm (in)	1511 (59.5)	
Ground clearance at unladen weight	mm (in)	175 (6.8)	
in normal-load position	mm (in)	150 (5.9)	
Turning circle	m (ft)	5.4 (17.7)	5.4 (17.7)



Weights		K 100 RS	K 100 RT/LT
Dry weight (without fuel, coolant, lubricants or tools)	kg (lb)	225 (496)	229 (505)
Unladen weight (ready for road, with tank fuel)	kg (lb)	253 (558)	253* (558) / 283 (624)
Gross weight limit	kg (lb)	480 (1058)	
Wheel load limits – front	kg (lb)	200 (441)	
– rear	kg (lb)	315 (694)	
Axle load distribution, front/rear at unladen weight	%	48/52	47/53
in normal-load position with 75 kg (165 lb) rider	%	45/55	44/56

*) without integral pannier cases.



created using
**BCL easyPDF
Printer Driver**

[Click here](#) to purchase a license to remove this image



For reliable
results . . .

Care and maintenance

Jobs you can perform yourself
if you wish:

- 'Beauty care'
- Storing the motorcycle
- Getting ready for the road again
- Checking oil levels/oil changes
- Checking disc brake lining
- Replacing the air cleaner element
- Battery maintenance
- Genuine BMW Parts and Accessories

. . . and jobs that are best left to
your qualified service technician

- **BMW Maintenance Program**

Care and
maintenance

'Beauty care'

Most motorcycle owners are familiar with the way an admiring crowd – of all ages – gathers round a sparkling, clean motorcycle whenever it is parked for a few minutes.

Who would not be just a little proud to receive this public recognition of his efforts?

Of course, there are many successful methods of cleaning. Most motorcyclists have devised their own ways of tackling the job.

Yet in view of the problems that can occur even with modern cleaning products and equipment, and the very real risk of damaging the motorcycle or spoiling its appearance, we have compiled a few hints which may be useful.

Note:

Many garages operate high-pressure water or steam cleaners, which are processes we do not recommend, because the powerful pressure may damage normal seals at the wheels, etc., may uplift paint damaged by stones and may also penetrate the breather covers at the gearbox and final drive and electrical or electronic equipment and fittings and the hydraulic brake system. The consequences can often be not only expensive to repair, but actually represent a safety hazard.

- A better approach: spray very dirty areas, e. g. wheels and transmission, with a mild-action engine or cold cleaner, allow this to soak in for the period of time specified by the supplier and then wash it off with a not-too-strong water jet. Tilt the motorcycle over to the left to drain water from the top of the engine. Finally, dry thoroughly.

After washing the motorcycle down in this way, it is advisable to test the brakes.

- Rubber and plastic components, particularly flashing turn indicators, rear light, instrument cluster, switches, etc., must be protected against cleansers and solvents.
- Wash paintwork with plenty of clean water, using a clean sponge or wash-leather. Remove dead insects in the same way. To eliminate tar stains, use only a commercial tar-stain remover; rinse down thoroughly afterwards.

Painted and chromium-plated areas should be treated with a good polish having a preservative action from time to time. This will preserve the motorcycle's smart appearance even if it is ridden all the year round and exposed to salt spread on the roads in winter.

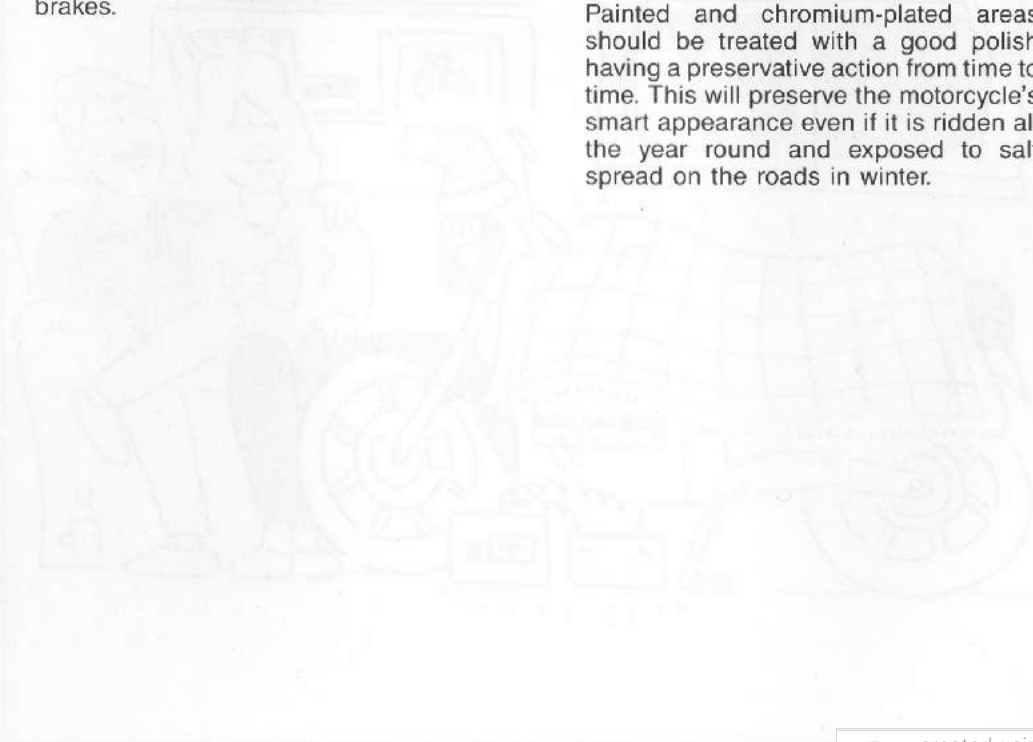

created using
**BCL easyPDF
Printer Driver**

[Click here to purchase a license to remove this image](#)

Concerning road salt: this is well known to attack motor vehicles of all kinds, and is particularly unkind to light alloys. You should therefore rinse down the motorcycle immediately after a journey with **cold water**; warm water increases the chemical action of the salt.

As a precautionary measure, a commercial wax-based corrosion proofing agent or similar product may be used.

- Minor paint damage caused by flying stones can be touched up easily and quickly with a BMW paint pencil. The motorcycle's paint color is stated on the label under the dualseat. The BMW Parts Service can also supply paint spray aerosols, though these are more difficult to use accurately.
- Only through proper care will your motorcycle finish be maintained. Avoid prolonged exposure to sunlight or your paint finish may fade or be damaged eventually. Cover your motorcycle when not in use.
- The polished stainless-steel exhaust system will gradually change its appearance in operation and as a result of exposure to the environment.

Please do not use any abrasive products to improve the finish of the exhaust system.

Storing the motorcycle

If you intend to store your motorcycle for any length of time, the following measures should be taken to maintain its value and to prevent internal corrosion:

- General care as specified in the manufacturer's maintenance instructions.
- Drain the engine oil while warm.
- Add a special corrosion-inhibiting oil up to the lower mark on the sight glass (approximately 2.5 l [2.6 quarts] are needed). Run the engine for about 1 minute off-load.
- Drain the oil from the gearbox and rear-wheel drive. Add approximately 0.4 l (0.4 quarts) of corrosion-inhibiting oil to the gearbox and approximately 0.1 l (0.1 quarts) to the rear-wheel drive. Select 2nd gear and run the engine for a few seconds.
- Take out and ground the spark plugs, while fitted in ignition caps, and inject approximately 10 cm³ of upper-cylinder preservative into each cylinder. Turn the engine over briefly with the starter motor. Screw the spark plugs back in.

Warning:

This motorcycle has a microprocessor-controlled high-performance digital ignition system. Touching any live components when the engine is running can cause a fatal electric shock.

- Remove the battery (see Pages 88 to 90) and have it stored and maintained by a specialist workshop if you have no suitable facilities of your own.
- Spray a suitable lubricant onto the brake and clutch lever pivots, and the center and prop stand pivot bearings.
- Coat all bright metal and chromium-plated steel parts with non-acid grease (Vaseline), and if necessary spray the entire motorcycle with corrosion-inhibiting oil.
- Store the motorcycle on its center stand in a dry room. Place blocks under the front of the engine, so that there is no load on either wheel.

Warning:

Gasoline is extremely flammable and is explosive under certain conditions. Perform this operation in a well-ventilated area. Do not smoke or allow flames or sparks in the area.

Note:

A motorcycle is often not used all year, therefore, proper battery care when in storage is of utmost importance to long battery life.



Getting the motorcycle ready for the road again

- Remove all protective materials applied to the exterior. Clean the motorcycle.
- Drain the corrosion-inhibiting oil from the engine, gearbox and rear-wheel drive. Renew the engine oil filter element and add fresh oil of the specified grade (see Pages 70 and 71). Renew the oil in the telescopic fork.
- Install a fully-charged battery, connect the leads and coat the terminal posts and clips with the correct grade of protective grease.
- Take out and ground the spark plugs, while fitted in ignition caps, run the starter motor and in this way eject the upper-cylinder preservative from the cylinders. Clean or replace the spark plugs as necessary and screw them back in.
- Check front and rear brake fluid level (see Page 18).
- Check tire pressures and correct if necessary.

Before the motorcycle is used again it is recommended that you have the above work combined with a BMW Inspection by your BMW dealer or a qualified service technician.

Oil changes

As we implied earlier, oil changes belong in the category of jobs which you **may** perform yourself if you wish.

But before you do so, please consider the following points.

Even assuming that you are among those riders capable of performing an oil change correctly, without allowing dirt to enter, using the correct parts and proceeding according to factory recommendations – what will become of the old oil and of the discarded filter element?

If you have oil changes carried out by a qualified service technician, you are no longer faced with these problems. And the cost is very reasonable compared with the time you may save.

Changing engine oil, renewing oil filter element

Always change the oil at normal operating temperature, every 6500 km (4000 miles), but at least every 6 months. If the motorcycle is used exclusively for short trips or only at temperatures below 32° F, change the oil every 3 months, or after 3250 km (2000 miles) at the latest.

When renewing the oil filter element in conjunction with an oil change, always fit the new filter element before adding fresh oil.



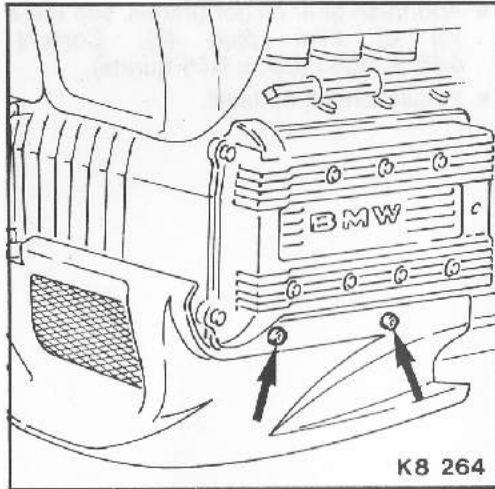

Changing engine oil, renewing oil filter element

Tools required:

- 5 mm and 8 mm Allen wrench
- Special wrench (for oil filter element)

Procedure:

- R 100 RS: Take out the 4 Allen screws (arrows).
- Remove the engine spoiler.

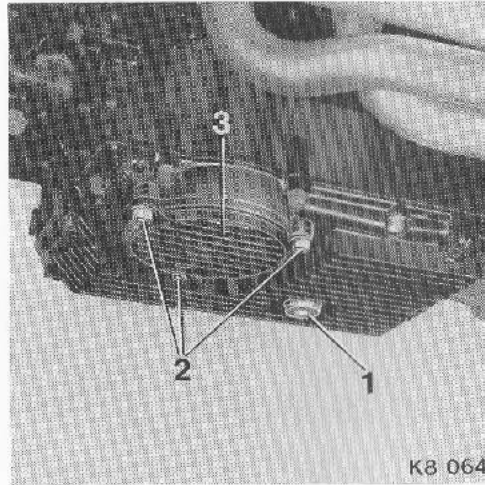

- Take out Allen screw (1) and allow the old oil to drain out. Insert and tighten the Allen screw (always use a new gasket)
- Take out the 3 Allen screws (2) and detach the oil filter cover (3).

Caution:

Make sure all gaskets are correctly positioned.

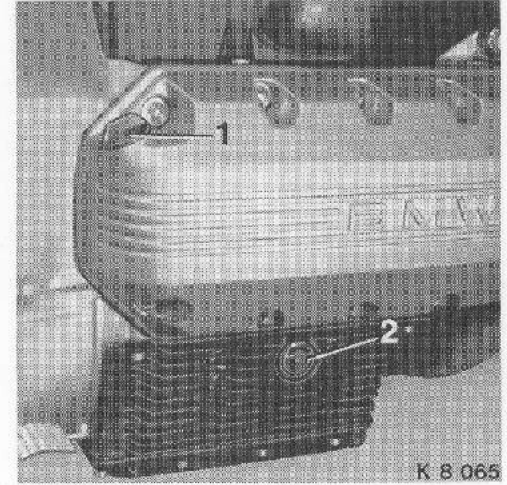

- Unscrew and remove the throwaway element. Before screwing in the new element, wet its sealing ring with oil. Screw in carefully, without using force.
- Attach the cover with a new gasket.
- Add fresh engine oil (for grades, see Page 70) at the filler cap (1). Content: 3.75 l (4.0 quarts).
- Run the engine, then switch it off and wait a few minutes before reading off the level at sight glass (2). See Page 17.

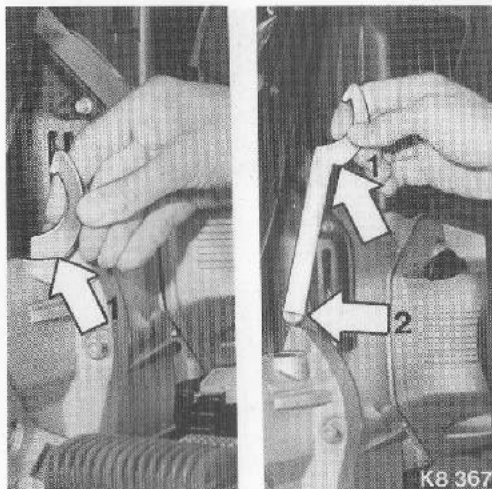

Checking gearbox oil level

Tools required:

- 8 mm Allen wrench
- Hook wrench for spring strut (to be used as a dipstick).

Procedure:

- Remove the oil filler screw (with Allen wrench)
- Insert the handle of the hook wrench fully (1).
- **The oil level should be up to mark (2) but no higher.** The bottom edge of the wrench serves as the minimum mark.

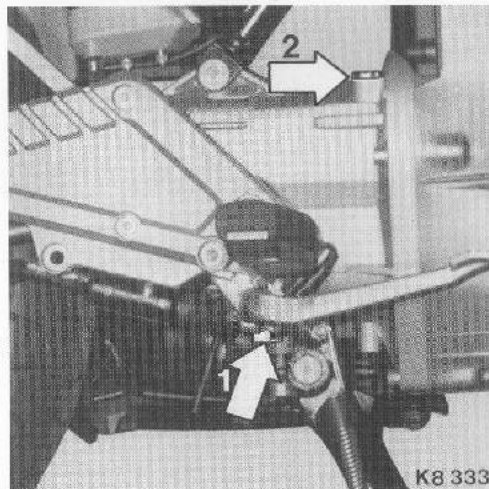

Gearbox oil change

Tools required:

- 8 mm Allen wrench
- 19 mm box wrench.

Procedure:

- Take out the oil drain plug (1) followed by the oil filler plug (2). Allow the old oil to drain out.
- Insert and tighten the oil drain plug (always use a new gasket).

- Add fresh gear oil (for grades, see Page 71) at filler plug (2). Content: 0.85 ± 0.05 l (0.9 ± 0.05 quarts).
- Finally, check oil level.



created using
BCL easyPDF
Printer Driver

[Click here](#) to purchase a license to remove this image

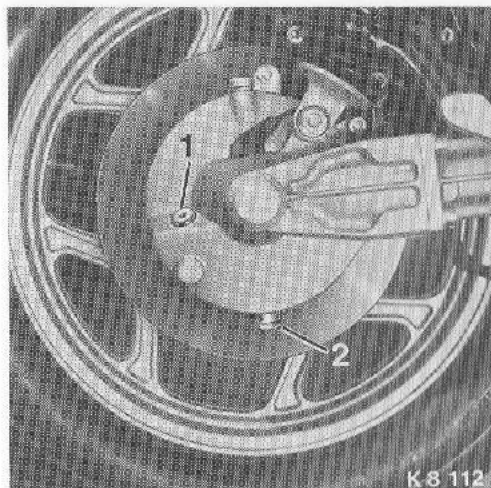

Checking oil level in rear-wheel drive

Tool required:

- 6 mm Allen wrench.

Procedure:

- Take out oil filler plug (1).
- With the motorcycle on its center stand, the oil level must be just up to the lowest turn of thread in the oil filler opening (approximately 12 mm [0.48 in.] below the sealing surface).

Rear-wheel drive oil change

Tools required:

- 6 mm Allen wrench
- 19 mm box wrench.

Procedure:

- Take out oil drain plug (2) followed by oil filler plug (1), and allow the old oil to drain off.
- Insert and tighten the drain plug (always use a new gasket).
- Add fresh gear oil (for grades, see Page 71) at filler (1).
Content: 0.26 l (9 ounces).

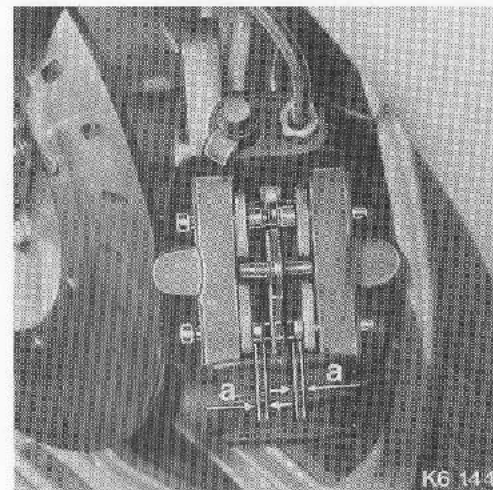

Checking disc brake lining

Tool required:

- Screwdriver (reversible blade)

Procedure:

- Lever the plastic cap away from the brake caliper with the screwdriver.
- Check the thickness of the brake pads. (The caliper has been removed here to provide a better illustration.)

Minimum lining thickness (a) 1.5 mm (1/16 inch).

Warning:

Never allow thickness to go below 1/16 of an inch, pads must be replaced.



created using
**BCL easyPDF
Printer Driver**

[Click here to purchase a license to remove this image](#)

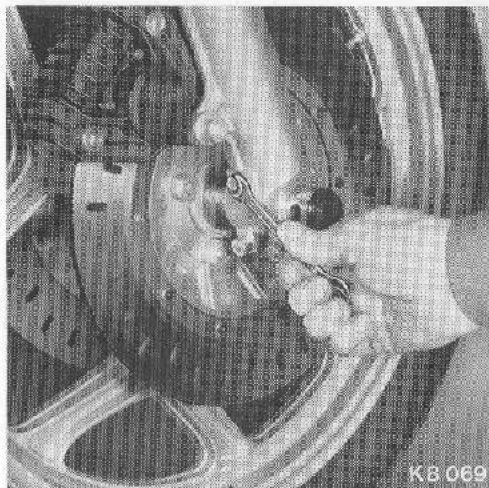

Telescopic fork oil change

Tools required:

- 10 and 22 mm open-ended wrenches
- 8 mm Allen wrench
- Screwdriver (with reversible blade).

Procedure:

- Unscrew the oil drain plugs from the left and right fork slider tubes, and drain off the old oil.
- Unscrew the oil filler plugs from the left and right fixed fork tubes, preventing these from turning with the open-ended wrench.
- Compress and extend the telescopic forks several times to expel all the old oil.

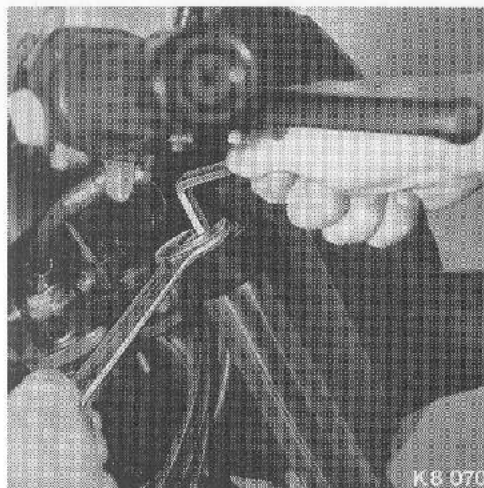

- Insert and tighten the drain plugs.
- Add fresh telescopic fork oil at the filler openings on the fork legs (for oil grades and content, see Page 71).
- After filling the fork legs, bleed the dampers by compressing and extending the telescopic fork 5 to 10 times, until the full damping effect becomes noticeable.
- Insert and tighten oil filler plugs.
- **Ensure that brake disc(s) are free of any fork oil that may have spurted onto disc(s) before moving motorcycle.**

Change the oil every 8000 miles, but at least once a year.

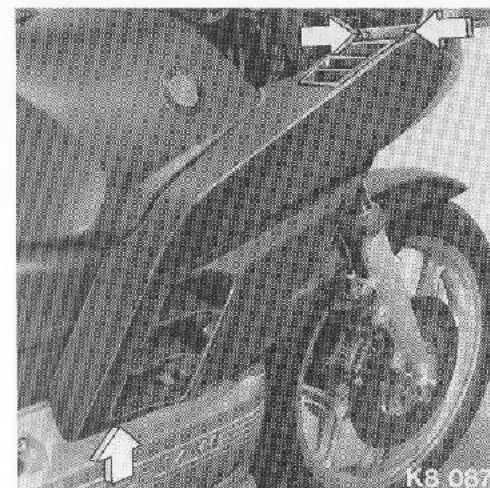

Replacing air cleaner element

Tool required:

- Screwdriver (with reversible blade).

Procedure – K 100 RS:

- Remove the retaining screws (arrows) for the right-side knee pad and take off the fairing from above.

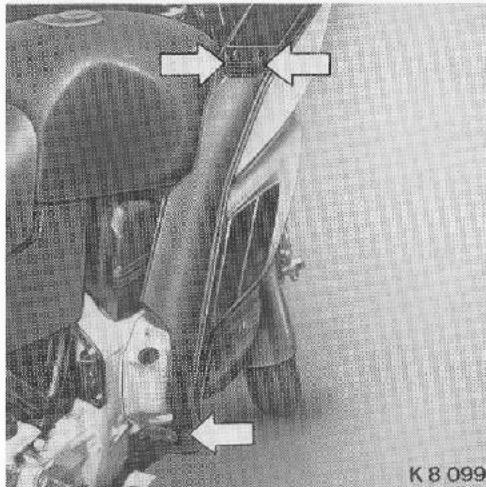

K 8 099

Procedure – K 100 RT:

- Release and remove the cover from the right-side storage compartment.
- Remove the retaining screws (arrows) for the right-side knee pad and take off the fairing to the rear from above.

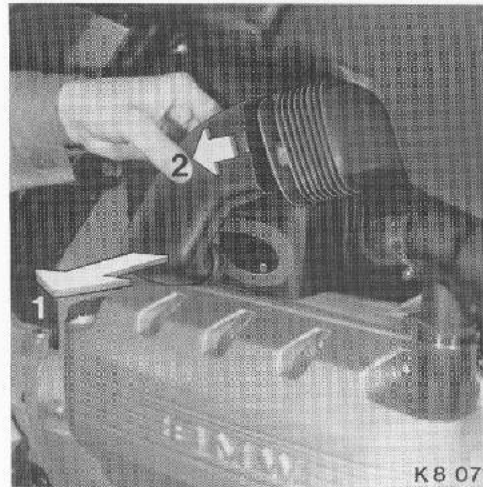

K 8 071

- Pull the air guide channel out of the lower part of the air cleaner in the direction of arrow (1) (moisten the rubber seat when installing).
- Remove the air guide channel to the rear as shown by arrow (2).



K 8 072

- Release the three spring clips connecting the upper and lower halves of the air cleaner housing.
- Raise the upper part slightly and pull the air cleaner element out to the right.
- Note correct installed position of air cleaner element, with inscription at the rear (looking forwards) and "TOP" arrow mark pointing upward.

Warning:

Never use gasoline or low flash point solvents for cleaning the cleaner element. A fire or explosion could result.

Always replace dirty air filter elements.



created using
**BCL easyPDF
Printer Driver**

[Click here to purchase a license to remove this image](#)

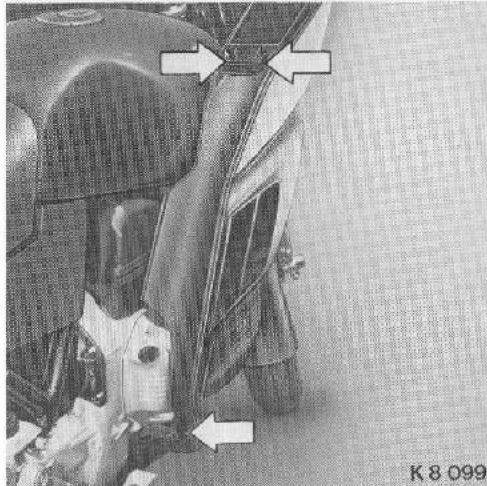

K 8 099

Procedure – K 100 RT:

- Release and remove the cover from the right-side storage compartment.
- Remove the retaining screws (arrows) for the right-side knee pad and take off the fairing to the rear from above.

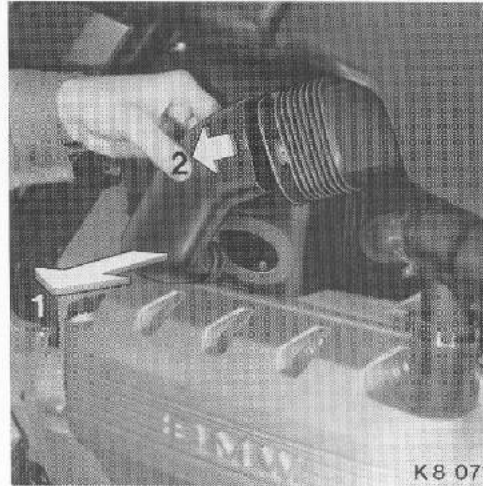

K 8 071

- Pull the air guide channel out of the lower part of the air cleaner in the direction of arrow (1) (moisten the rubber seat when installing).
- Remove the air guide channel to the rear as shown by arrow (2).



K 8 072

- Release the three spring clips connecting the upper and lower halves of the air cleaner housing.
- Raise the upper part slightly and pull the air cleaner element out to the right.
- Note correct installed position of air cleaner element, with inscription at the rear (looking forwards) and "TOP" arrow mark pointing upward.

Warning:

Never use gasoline or low flash point solvents for cleaning the cleaner element. A fire or explosion could result.

Always replace dirty air filter elements.



created using
BCL easyPDF
Printer Driver

[Click here to purchase a license to remove this image](#)

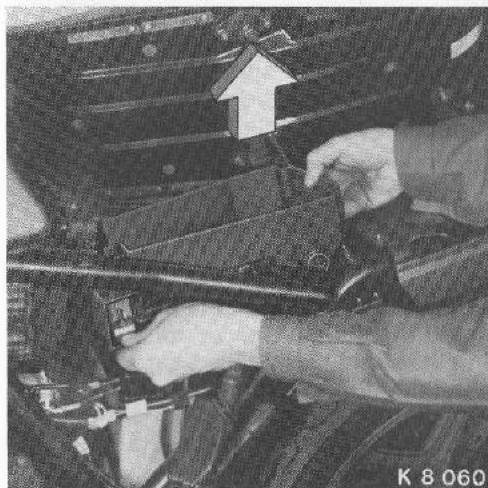

K 8 060

- Lift storage tray with fuel injection control unit out of its mounting (arrow).
- Disconnect the battery (first the negative, then the positive lead).

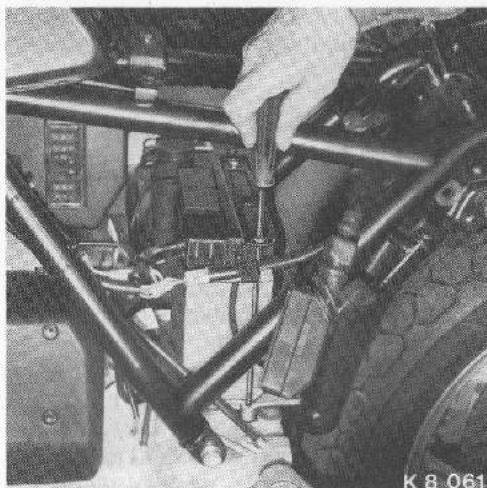

K 8 061

- Dismantle the battery holder.

Installation:

To prevent possible damage to the battery casing, do not overtighten the battery holder screws.



K 8 062

- Remove the battery from the frame upwards and to the rear.

Installation:

Guide the battery vent tube through the hole at the base of the rear mudguard.



created using
**BCL easyPDF
Printer Driver**

[Click here](#) to purchase a license to remove this image

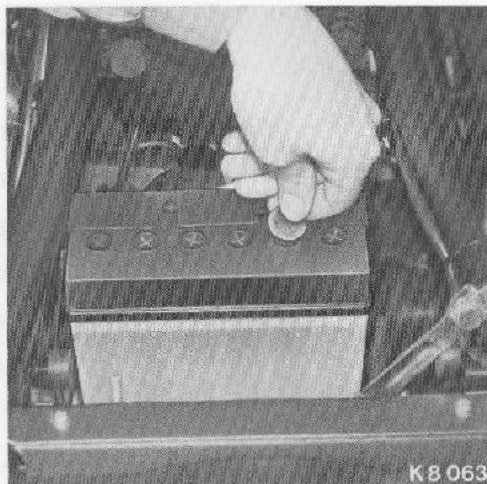

Checking battery acid level

The acid level in the battery can be checked with the battery in position on the motorcycle, thanks to the transparent battery casing.

It should be 5 . . . 10 mm below the black upper section of the battery.

Use only distilled water to top off the battery. For access to the filler plugs, see "Removing and installing battery".

The sealing plugs can easily be unscrewed and retightened with a suitable coin.

Further maintenance instructions:

The life of a battery greatly depends on its state of charge.

Recommended procedure:

- During the normal riding season, the battery should remain well charged if the acid level is correct, since the alternator produces a generous charge at all normal engine speeds.
- If the motorcycle is not ridden regularly, for instance in winter, remove its battery and at about monthly intervals have it recharged at a current equal to approx. 10% of the battery's nominal rating.

Example:

25 Ah (ampère-hour) battery:
max. charging current 2.5 Amp.

30 Ah battery:
max. charging current 3 Amp.

The state of battery charge is determined by measuring the specific gravity of the battery acid.

- Another way of maintaining battery charge is by trickle charging at approx. on-third Amp. A suitable trickle charger can be left connected to the battery whenever the motorcycle is not in use.

Warning:

The battery contains sulfuric acid. Avoid contact with skin, eyes or clothing. Antidote: EXTERNAL-Flush with water, INTERNAL-Drink large quantities of water or milk. Follow with milk of magnesia, beaten egg or vegetable oil. Call physician immediately. Eyes: Flush with water and get prompt medical attention.

Batteries produce explosive gases. Keep sparks, flames and cigarettes away. Always shield eyes when working near batteries.

KEEP OUT OF REACH OF CHILDREN
Recharge battery only in a well-ventilated area. Filler caps must be tight.

Caution:

Battery acid is corrosive to metal or enamel surfaces. Before recharging or removing a battery, always switch off engine and disconnect the terminals. Never run the engine without the battery connected, or else the alternator may be destroyed. Check that battery venting hose is routed correctly, and open.



created using
**BCL easyPDF
Printer Driver**

[Click here to purchase a license to remove this image](#)

The BMW maintenance program

Before you receive the new motorcycle from your authorized BMW motorcycle dealer, a **pre-delivery check** is carried out. Details of this work and confirmation are in the Proof of Ownership/Service History booklet, which will be supplied with each motorcycle.

Proof that all maintenance work has been carried out correctly is a most useful selling point if you later sell your motorcycle.

Note:

This is vital in case you have warranty repairs performed.

After the **First Inspection at approx. 600 miles**, a regularly spaced routine of servicing work commences.

At speedometer reading 4000 miles, a **BMW Inspection I** is due. Starting at 8000 miles, the more comprehensive **BMW Inspection II** should be carried out.

After this, BMW Inspection I and II are due alternately every 4000 miles.

In the interests of reliability and long, troublefree operation of your motorcycle, it is recommended to have **at least one BMW Inspection a year** carried out, even if the distance specified in the BMW maintenance program has not been covered.

Please remember to bring the Proof of Ownership/Service History booklet with you when you have an appointment for motorcycle servicing work at the qualified Service Technician's Shop. Always carry these documents with you when you travel, in case repairs are necessary.



created using
**BCL easyPDF
Printer Driver**

[Click here to purchase a license to remove this image](#)

tical
Item Index

Genuine BMW Parts and Accessories

Superior design and engineering inspire confidence. It doesn't take far to discover this when you ride a BMW.

A high-quality motorcycle needs expert maintenance and general care, and will then provide you with the same high level of riding pleasure for many years to come.

We recommend that you have your BMW motorcycle serviced and repaired only by an authorized BMW motorcycle dealer or service station. They concentrate on BMW products and possess all the necessary special tools and equipment.

Spare parts are available from many sources, but Genuine BMW Parts are identical in every respect with the parts originally fitted to your new BMW motorcycle.

The use of replacement parts, which are not of equivalent quality, may impair the performance of your motorcycle. You should obtain assurances that such parts are warranted by the manufacturer to be equivalent to Genuine BMW Parts in performance and durability.

Every authorized BMW dealer maintains a stock of the BMW spare parts and exchange assemblies most frequently needed.

Your authorized BMW motorcycle dealer will gladly supply full details of our extensive range of accessories and a complete selection of BMW motorcyclists' clothing.

Warning:

Several components of the motorcycle's equipment contain asbestos fibers.

Danger!

Avoid breathing asbestos dust as it is dangerous to your health.

– Cancer and lung disease hazard –

Quality guarantee

Genuine BMW Parts are completely identical with the equivalent parts on new BMW vehicles.

BMW hereby issues a warranty* in respect of these parts' freedom from defects in materials and workmanship.

BMW – Perfection in Detail

* Warranty details are available in the Consumer Warranty Information booklet issued with your motorcycle.



created using
**BCL easyPDF
Printer Driver**

[Click here to purchase a license to remove this image](#)

Alphabetical Item Index

A...Z



created using
**BCL easyPDF
Printer Driver**

[Click here to purchase a license to remove this image](#)

Alphabetical item index

Accessories 30
 Additives 15
 Air cleaner element – replacing 86, 87
 Alternator 12, 73
 Antifreeze 51–54
 Antifreeze mixing ratio 53
 Axle loads/distribution 76

 Battery 73
 Battery, removing and installing 88, 89
 Battery acid level – checking 90
 Battery cover – removing 47, 88
 Battery maintenance instructions 90
 Battery terminal posts 71
 Beam throw adjustment 43, 45
 “Beauty care” 28, 80
 Bore 58
 Brake fluid 18, 29, 71
 Brake fluid content 71
 Brake fluid level 18
 Brake fluid renewal 29
 Brake fluid reservoirs 18
 Brake light 29, 74
 Brake light – changing bulb 46
 Brake lining 35, 68, 85
 Brake pedal adjustment 19
 Brakes 28
 Breakdowns, 36–56
 Breakdown repair accessories 30, 36
 Breaking-in period 35
 Breaking-in rules 35
 Bulb changing 40–46
 Bulbs 74

Capacity (engine) 58
 Care and maintenance 28, 80–91
 Cases 30
 Caster (front wheel) 67
 Center stand 24
 Charging current 90
 Choke control (increased cold-start engine speed) 21
 Circuit diagram, electrical 72
 Circuit protection 47, 74
 Cleaning products and equipment 80, 81
 Clock 16
 Clothing 32
 Clutch 66
 Clutch – adjusting 19, 54
 Clutch lever – checking 19
 Clutch lever – free travel 19
 Cold-start (increased engine speed) 21
 Compression ratio 58
 Condition of motorcycle 28
 Coolant – adding 51–54
 Coolant concentration 53
 Coolant – draining 54
 Coolant equalizing tank 17, 51
 Coolant level 17, 35, 51–54
 Coolant overheat warning light 35, 55
 Coolant – renewing 54
 Coolant temperature 55
 Cooling fan 55, 60
 Cooling system 51–55
 Cooling system content 54, 70
 Cooling system data 60
 Cooling system filler cap 51
 Cooling system, operating diagram 61
 Corrosion-inhibiting oil 81
 Corrosion protection 81

Digital clock with LCD display 16
 Digital clock – adjusting 16
 Digital ignition system 29, 64
 Dimensions 75
 Displacement (engine) 58
 Do-it-yourself 56
 Dry weight 76
 Dualseat lock 15

 Electrical circuit diagram 72
 Electrical circuits 47, 74
 Electrical system 73, 74
 Electrode gaps (spark plugs) 48, 73
 Electronic burglar alarm 26
 Emergency engine cut-out switch 21
 Engine idle speed 58
 Engine lubricating system 60
 Engine lubricating system data 60
 Engine oil 70
 Engine oil, approved grades 70
 Engine oil change 83
 Engine oil consumption, maximum 58
 Engine oil content 17, 70, 83
 Engine oil level 17, 83
 Engine oil pressure 12
 Engine oil pressure telltale 22
 Engine speed 23
 Engine speed, continuous 58
 Engine speed governor 64
 Engine speed limits 35
 Engine speed – maximum permissible 58
 Engine overheat warning light 34, 55
 Engine temperature 35
 Engine type 58, 59



- Fan 55, 60
- Final drive ratio 66
- Firing order 73
- Foot brake adjustment 19
- Foot brake – checking 19
- Frame 67–69
- Front brake 68
- Front brake – checking 19
- Front brake lever – free travel 19
- Front suspension 67
- Front wheel – removing and installing 37
- Fuel 15, 58
- Fuel, adding 14
- Fuel grade 15, 58
- Fuel injection control unit 88, 89
- Fuel injection operating diagram 63
- Fuel injection system 62
- Fuel level 12, 18
- Fuel level telltale light 12, 18
- Fuel shutoff on overrun 62
- Fuel tank capacity 18
- Fuel tank filler cap 14
- Fuel tank, detaching 52, 53
- Fuses 47, 74
- Fuses – renewing 47

- Gear ratios 66
- Gearbox 23, 66
- Gearbox oil change 84
- Gearbox oil content 71, 84
- Gearbox oil level 84
- Gear change 23
- Gear indicator, digital 22
- Getting ready for road again 82
- Gross weight 76
- Ground clearance 75

- Hall-effect transmitter 64
- Halogen (H 4) bulb – changing 41, 42
- Handbrake lever – checking 19
- Handbrake lever – free travel 19
- Handle (for putting on stand) 24
- Handlebar fittings 14
- Headlight 74
- Headlight beam setting 43, 45
- Headlight removal 40–45
- Helmet 31
- Helmet holder 15, 25
- High beam headlight 74

- Identical keys 12
- Ignition control (advance and retard) 64
- Ignition cut-out switch 14, 21
- Ignition switch 12
- Ignition system, high performance 29, 64
- Ignition system – operating diagram 65
- Ignition timing 73
- Illustrations (complete side views) 8–11
- Instrument cluster – bulbs 74
- Integral saddlebags 30

- Keys 12

- L-Jetronic fuel injection – operating diagram 63
- Length, overall 75
- Licence plate holder 38
- Lights 29
- Load, permissible 30
- Locks, identical 12, 25

- Long journeys 30
- Low beam headlight 74
- Low fuel level telltale light 12
- Lubricants, etc. 70, 71
- Lubricating system data 60
- Luggage carrier 30
- Luggage space 15, 16
- Luggage weight limit 30

- Main beam headlight 74
- Maintenance program 28, 91
- Manual headlight
 - beam adjustment 43, 45
- Minor repairs 36
- Minor repair accessories 36
- Monolever 67
- Monoshock settings 19

- Octane number 58
- Oil consumption, maximum 58
- Oil filter element – renewing 83
- Oil grades, approved 70, 71
- Oil level 17
- Oil pressure 12
- Oil viscosities 70, 71
- Overrun fuel shutoff 62

- Paint designation 81
- Paint touch-up pencil 81
- Parking light 74
- Parking light bulb – renewing 40–45
- Parts and Accessories, Genuine BMW 56, 92
- Personal safety 28
- Pre-delivery check 91



- Radiator 60
- Radio/Cassette player 32
- Rainsuit 15
- Ratios – gearbox 66
- Rear brake 68
- Rear light 74
- Rear light bulb – replacing 46
- Rear light monitor 12
- Rear suspension 67
- Rear suspension – adjusting 19
- Rear wheel centering spigot 39
- Rear-wheel drive 66
- Rear-wheel drive oil change 85
- Rear-wheel drive oil content 71, 85
- Rear-wheel drive oil level 85
- Rear wheel – removing and installing 38, 39
- Rear wheel studs – tightening torque 39
- Refuelling 14, 15

- Safety checks 17–20
- Safety features 28, 29
- Salt on roads – effects on motorcycle 80, 81
- Seat height 75
- Service 91
- Service accessories 30
- Service confirmations 91
- Servicing and breakdown accessories 30, 36
- Side stand 24
- Spark plug caps 48
- Spark plug cover 48
- Spark plug gaps 48, 73
- Spark plugs 49, 73
- Spark plugs – replacing 48
- Spark plugs – tightening torque 48

- Specifications and technical descriptions 58–78
- Speedometer, electronic 66
- Spring strut settings 19
- Starter motor 73
- Starter-repeat inhibit lock 64
- Starting the engine 21
- Steering head bearings – lubricating 71
- Steering lock 25
- Steering lock (front wheel turning) angle 67
- Storage compartments 15, 16
- Storage tray 9, 15, 88
- Storing the motorcycle 81
- Stroke 58
- Suspension, front 67
- Suspension, rear 67
- Swinging arm 67
- System helmet 31

- Tank filler cap 14
- Tank-top rucksack 30
- Telescopic fork oil change 86
- Telescopic fork oil content 71, 86
- Telescopic fork oil grades 71
- Telltale and warning lights 12, 13, 18, 22
- Thermostat 60, 61
- Tire pressures 20, 28, 69
- Tire repair kit 36
- Tire sizes 69
- Tire tread depth 69
- Tires and wheels 28, 69
- Tires – make, type and size 29, 69
- Tires, breaking in 35
- Transmission 66
- Tread depth (tires) 69

- Trip distance recorder – resetting 13
- Troubleshooting 55
- Turn indicator bulbs 74
- Turn indicator bulb – replacing 46
- Turning circle 75
- Type plate 10, 67

- Unladen weight 76
- Upper-cylinder preservative (when storing the motorcycle) 81

- Vehicle identification number 10, 67
- Viscosities (oil) 70, 71

- Warranty claims 91
- Weight distribution 30
- Weight, gross 76
- Weight, unladen 76
- Weights 76
- What to do if . . . 55
- Wheelbase 75
- Wheel bearing lubrication 71
- Wheel sizes 69
- Wheels, removing and installing 37–39
- Width 75
- Windscreen spoiler adjustment 16
- Wiring diagram, electrical 72



